

General Relativity

HS 14

G.M. Graf

ETH Zürich

Contents

1	Manifolds and tensor fields	1
1.1	Differentiable manifolds	1
1.2	Tensor fields	5
1.3	The Lie derivative	9
1.4	Differential forms	10
2	Affine connections	17
2.1	Parallel transport and covariant derivative	17
2.2	Torsion and curvature	19
2.3	The Cartan structure equations	23
3	Pseudo-Riemannian manifolds	25
3.1	Metric	25
3.2	The Levi-Civita connection	26
3.3	Supplementary material	29
4	Time, space and gravitation	32
4.1	The classical relativity principle	32
4.2	The Einstein equivalence principle	32
4.3	The postulates of general relativity (GR)	34
4.4	Transition SR \rightarrow GR	35
4.5	Transition geodesic equation \rightarrow Newton's equation of motion	37
4.6	Geodesic deviation	39

5	The Einstein field equations	41
5.1	The energy-momentum tensor	41
5.2	Field equations of gravitation	43
5.3	The Hilbert action	45
6	Homogeneous isotropic universe	50
6.1	The ansatz	50
6.2	Expansion	51
6.3	The Friedmann equations	53
6.4	Which universe?	60
6.5	The causality and flatness problems	62
6.6	Redshift and symmetries	63
7	The Schwarzschild-Kruskal metric	66
7.1	Stationary and static metrics	66
7.2	The Schwarzschild metric	68
7.3	Geodesics in the Schwarzschild metric	71
7.4	The Kruskal extension of the Schwarzschild metric: Black Hole	74
7.5	The Kerr metric and rotating black holes	78
7.6	Hawking radiation	81
8	The linearized theory of gravity	90
8.1	The linearized field equations	90
8.2	Gauge transformations and gauges	91
8.3	Gravitational waves	94
8.4	Emission of radiation	96

The author is indebted to W. Hunziker (†), whose lecture notes are largely at the basis of these, to Ms. A. Schultze for careful typing, and to V. Beaud for spotting many mistakes. He welcomes comments and notices of misprints at gmgraf@itp.phys.ethz.ch.

1. Manifolds and tensor fields

1.1. Differentiable manifolds

A **differentiable manifold** M is “locally homeomorphic to \mathbb{R}^n ”, meaning it is defined by the following elements:

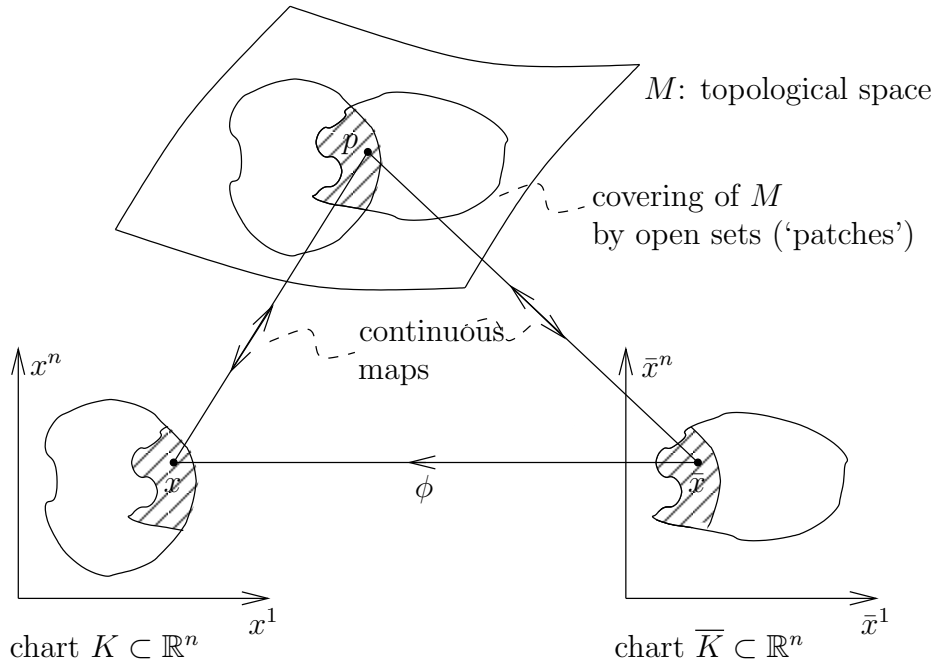

Within the shaded overlap region of two charts the change of coordinates $\bar{x} \leftrightarrow x$ (transition functions ϕ, ϕ^{-1}) are differentiable any number of times. Definition: $\dim M = n$.

Notions

- Differentiable functions $f : M \rightarrow \mathbb{R}$ (algebra $\mathcal{F} = C^\infty(M)$)
- \mathcal{F}_p : algebra of C^∞ -functions defined in any neighborhood of p ($f = g$ means $f(q) = g(q)$ in some neighborhood of p)
- Differentiable curve $\gamma : \mathbb{R} \rightarrow M$
- Differentiable map: $M \rightarrow M'$

The notions are to be understood by means of a chart: e.g. $f : M \rightarrow \mathbb{R}$ is differentiable if $x \mapsto f(p(x)) \equiv f(x)$ is. This is independent of the chart representing a neighborhood of p .

Tangent space T_p of the point $p \in M$

A **vector** $X \in T_p$ is a linear map $\mathcal{F}_p \rightarrow \mathbb{R}$ with the derivation property

$$X(fg) = (Xf)g(p) + f(p)(Xg) . \tag{1.1}$$

T_p is a linear space. In any chart (representing p) we have

$$Xf = X^i f_{,i}(x) \quad : \quad X^i = X(x^i) ,$$

where $f_{,i} = \partial/\partial x^i$ and $x^i \in \mathcal{F}_p$ denotes the coordinate function $p \mapsto x^i$. Note the summation convention: each index appearing once as upper and once as lower index is to be summed over from 1 to n .

Proof. For $f \equiv 1$ we have $f^2 = f$, whence $Xf = 2Xf = 0$. Thus $Xf = 0$, if f is constant. Let p have coordinates $x = 0$. The identity

$$f(x) = f(0) + \underbrace{x^i \int_0^1 dt f_{,i}(tx)}_{g_i(x)}$$

implies by (1.1) $Xf = X(x^i) \cdot g_i(0) = X^i f_{,i}(0)$. □

Directional derivative

Let $\gamma(t) \in M$ be a curve through $\gamma(0) = p$. Then γ defines a vector $X \in T_p$ through

$$Xf = \left. \frac{d}{dt} f(\gamma(t)) \right|_{t=0} , \tag{1.2}$$

denoted by $X = \dot{\gamma}(0)$. In components:

$$X^i = \left. \frac{d\gamma^i}{dt} \right|_{t=0}$$

($\gamma^i =$ coordinates of γ). One can thus regard a tangent vector X as an equivalence class of curves through p sharing the same tangent vector there.

Basis of T_p

T_p has dimension n . In any basis (e_1, \dots, e_n) we have

$$X = X^i e_i .$$

Change of basis:

$$\begin{array}{ccc} \bar{e}_i = \phi_i^k e_k , & \bar{X}^i = \phi^i_k X^k & (1.3) \\ \uparrow & \uparrow & \\ & \text{inverse-transposed} & \end{array}$$

In particular $e_i = \partial/\partial x^i$ is called **coordinate basis** (w.r.t. a chart). Upon change of chart,

$$\phi_i^k = \frac{\partial x^k}{\partial \bar{x}^i} , \quad \phi^i_k = \frac{\partial \bar{x}^i}{\partial x^k} . \tag{1.4}$$

The cotangent space T_p^*

Dual space of T_p : a **covector** $\omega \in T_p^*$ is a linear form

$$\omega : X \mapsto \omega(X) \equiv \langle \omega, X \rangle \in \mathbb{R} ,$$

where $\langle \cdot, \cdot \rangle$ is called duality bracket. In particular, for any $f \in \mathcal{F}_p$

$$df : X \mapsto Xf$$

is an element of T_p^* . The elements $df = f_i dx^i$ form a linear space of dimension n , hence all of T_p^* .

Basis (e^1, \dots, e^n) of T_p^* :

$$\omega = \omega_i e^i .$$

In particular the **dual basis** (of a basis (e_1, \dots, e_n) of T_p) is given by

$$\langle e^i, X \rangle = X^i , \quad \text{or} \quad \langle e^i, e_k \rangle = \delta^i_k .$$

Thus $\omega_i = \langle \omega, e_i \rangle$. Upon changing the basis the ω_i transform like the e_i and the e^i like the X^i (cf. (1.3)). In particular we have for the coordinate basis

$$e_i = \frac{\partial}{\partial x^i} , \quad e^i = dx^i .$$

The change of basis then is

$$\frac{\partial}{\partial \bar{x}^i} = \frac{\partial x^k}{\partial \bar{x}^i} \frac{\partial}{\partial x^k} , \quad d\bar{x}^i = \frac{\partial \bar{x}^i}{\partial x^k} dx^k .$$

Remark. Sometimes vectors X and covectors ω are called contravariant and covariant vectors, respectively. This alludes to the transformation law of their components X^i and ω_i , which is opposite (*contra*), respectively alike (*co*) that of the change of basis (e_i) .

Tensors on T_p

Tensors are multilinear forms on T_p^* and T_p , e.g. a tensor T of type $\binom{1}{2}$ (for short: $T \in \otimes_2^1 T_p$): $T(\omega, X, Y)$ is a trilinear form on $T_p^* \times T_p \times T_p$. In particular $\otimes_1^0 T_p = T_p^*$, $\otimes_0^1 T_p = (T_p^*)^* \cong T_p$, as well as $\otimes_0^0 T_p = \mathbb{R}$. General tensors are of type $\binom{r}{s}$ with $r, s \in \mathbb{N}$ and sometimes called r times contravariant and s times covariant. They take as arguments r and s vectors of the opposite kinds.

The **tensor product** is defined between tensors of any type, e.g.

$$T(\omega, X, Y) = R(\omega, X) \cdot S(Y) : \quad T = R \otimes S .$$

Components (w.r.t. a pair of dual bases)

$$T(\omega, X, Y) = \underbrace{T(e^i, e_j, e_k)}_{\equiv T^i_{jk}} \underbrace{\omega_i X^j Y^k}_{e_i(\omega) e^j(X) e^k(Y)} ,$$

hence

$$T = T^i_{jk} e_i \otimes e^j \otimes e^k .$$

Any tensor of this type can therefore be obtained as a linear combination of tensor products $X \otimes \omega \otimes \omega'$ with $X \in T_p$, $\omega, \omega' \in T_p^*$, denoted as $\otimes_2^1 T_p = T_p \otimes T_p^* \otimes T_p^*$.

Change of basis

$$\bar{T}^i_{jk} = T^\alpha_{\beta\gamma} \phi^\beta_\alpha \phi_j^\beta \phi_k^\gamma . \tag{1.5}$$

Trace

Any bilinear form $b \in T_p^* \otimes T_p$ determines a linear form $l \in (T_p \otimes T_p^*)^*$ such that

$$l(X \otimes \omega) = b(X, \omega) .$$

$$\begin{array}{ccc} T_p \times T_p^* & \xrightarrow{b} & \mathbb{R} \\ \downarrow \otimes & \nearrow l & \\ T_p \otimes T_p^* & & \end{array}$$

Proof. The map $l \mapsto b$ is one-to-one and on grounds of dimension also onto. \square

In particular $\text{tr} T$ is a linear form on tensors T of type $\binom{1}{1}$ defined by

$$\text{tr}(X \otimes \omega) = \langle \omega, X \rangle .$$

In components w.r.t. a dual pair of bases we have

$$\text{tr} T = T^i{}_i .$$

Similarly,

$$T^i{}_{jk} \mapsto S_k = T^i{}_{ik}$$

defines for instance a map from tensors of type $\binom{1}{2}$ to tensors of type $\binom{0}{1}$.

The tangent map

Let φ be a differentiable map $M \rightarrow \bar{M}$; let $p \in M$ and $\bar{p} = \varphi(p)$. Then φ induces a linear map

$$\varphi_* : T_p(M) \rightarrow T_{\bar{p}}(\bar{M}) ,$$

called the **tangent map** of φ (or push forward), which we describe in two ways:

(a) For any $\bar{f} \in \mathcal{F}_{\bar{p}}(\bar{M})$ set

$$(\varphi_* X) \bar{f} = X(\bar{f} \circ \varphi) .$$

(b) Let γ be a representative of X (cf. (1.2)). Then let

$$\bar{\gamma} = \varphi \circ \gamma$$

be a representative of $\varphi_* X$. This agrees with (a), because

$$\frac{d}{dt} \bar{f}(\bar{\gamma}(t)) \Big|_{t=0} = \frac{d}{dt} (\bar{f} \circ \varphi)(\gamma(t)) \Big|_{t=0} .$$

W.r.t. bases (e_1, \dots, e_n) of T_p , $(\bar{e}_1, \dots, \bar{e}_{\bar{n}})$ of $T_{\bar{p}}$ reads $\bar{X} = \varphi_* X$

$$\bar{X}^i = (\varphi_*)^i{}_k X^k$$

with $(\varphi_*)^i{}_k = \langle \bar{e}^i, \varphi_* e_k \rangle$ or, in case of coordinate bases,

$$(\varphi_*)^i{}_k = \frac{\partial \bar{x}^i}{\partial x^k} .$$

The **adjoint map** φ^* (or pull back) of φ_* is

$$\varphi^* : T_{\bar{p}}^* \rightarrow T_p^* , \quad \bar{\omega} \mapsto \varphi^* \bar{\omega}$$

with

$$\langle \varphi^* \bar{\omega}, X \rangle = \langle \bar{\omega}, \varphi_* X \rangle .$$

The same result is obtained from the definition

$$\varphi^* : d\bar{f} \mapsto d(\bar{f} \circ \varphi) , \quad (\bar{f} \in \mathcal{F}(\bar{M})) . \quad (1.6)$$

In components, $\omega = \varphi^* \bar{\omega}$ reads

$$\omega_k = \bar{\omega}_i (\varphi_*)^i_k .$$

Comparison with $\omega_k = (\varphi^*)_k^i \bar{\omega}_i$ gives $(\varphi^*)_k^i = (\varphi_*)^i_k$: the matrices for φ^* and φ_* are transposed.

Given a further map $\psi : \bar{M} \rightarrow \bar{M}$ one has

$$(\psi \circ \varphi)_* = \psi_* \varphi_* , \quad (\psi \circ \varphi)^* = \varphi^* \psi^* , \quad (1.7)$$

where the composition of linear maps is written without \circ .

From now on we limit ourselves to (local) diffeomorphisms. These are maps φ such that φ^{-1} exists in a neighborhood of \bar{p} , i.e.

$$\dim M = \dim \bar{M} , \quad \det \left(\frac{\partial \bar{x}^i}{\partial x^k} \right) \neq 0 .$$

Then φ_* and φ^* are invertible and may be extended to tensors of arbitrary type. They are naturally called pushforward, resp. pullback of φ .

Example. Type $\binom{1}{1}$:

$$\begin{aligned} (\varphi_* T)(\bar{\omega}, \bar{X}) &= T(\varphi^* \bar{\omega}, \varphi_*^{-1} \bar{X}) , \\ (\varphi^* \bar{T})(\omega, X) &= \bar{T}(\varphi_*^{-1} \omega, \varphi_* X) . \end{aligned}$$

Here, φ_* , φ^* are each other's inverse and we have

$$\begin{aligned} \varphi_*(T \otimes S) &= (\varphi_* T) \otimes (\varphi_* S) , \\ \text{tr}(\varphi_* T) &= \varphi_*(\text{tr} T) \end{aligned} \quad (1.8)$$

(tr = any trace) and similarly for φ^* . In components $\bar{T} = \varphi_* T$ reads

$$\bar{T}^i_k = T^\alpha_\beta \frac{\partial \bar{x}^i}{\partial x^\alpha} \frac{\partial x^\beta}{\partial \bar{x}^k} \quad (1.9)$$

(coordinate bases). This is formally the same as the transformation (1.5) when changing basis.

1.2. Tensor fields

A **vector field** on M is a linear map $X : \mathcal{F} \rightarrow \mathcal{F}$ with the derivation property

$$X(fg) = (Xf)g + f(Xg) . \quad (1.10)$$

This implies that $(Xf)(p)$ depends only on the equivalence class $f \in \mathcal{F}_p$. **Proof:** From $f = 0$ in a neighborhood U of p we conclude by means of a function g with $\text{supp } g \subset U$, $g(p) = 1$, that $(Xf)(p) = 0$. \square

Hence, for any $p \in M$

$$X_p : f \mapsto (Xf)(p)$$

is a vector in T_p . In a chart we thus have

$$(Xf)(x) = X^i(x)f_{,i}(x), \quad \text{i.e.} \quad X = X^i(x) \frac{\partial}{\partial x^i}$$

with smooth components $X^i(x)$: vector fields are linear differential operators of first order. The vector fields on M form a linear space on which the following operations are defined as well

$$\begin{aligned} X &\mapsto fX && \text{(multiplication by } f \in \mathcal{F} \text{),} \\ X, Y &\mapsto [X, Y] = XY - YX && \text{(commutator).} \end{aligned}$$

Indeed, $[X, Y]$, unlike XY , satisfies (1.10):

$$\begin{aligned} [X, Y](fg) &= X((Yf)g + f(Yg)) - Y((Xf)g + f(Xg)) \\ &= ([X, Y]f)g + f([X, Y]g). \end{aligned}$$

In components (coordinate basis):

$$(fX)^i = fX^i, \quad [X, Y]^i = X^j Y^i_{,j} - Y^j X^i_{,j}.$$

Moreover the Jacobi identity holds true

$$[X, [Y, Z]] + [Y, [Z, X]] + [Z, [X, Y]] = 0. \quad (1.11)$$

1-forms (or covector fields) are “ \mathcal{F} -linear” maps

$$\omega : X \mapsto \omega(X) \in \mathcal{F}$$

from the space of vector fields to \mathcal{F} , i.e.,

$$\begin{aligned} \omega(X + Y) &= \omega(X) + \omega(Y), \\ \omega(fX) &= f\omega(X), \quad (f \in \mathcal{F}). \end{aligned}$$

This is stronger than mere linearity ($f \rightsquigarrow \lambda \in \mathbb{R}$). It implies that $\omega(X)(p)$ depends only on X_p . **Proof:** chart: $p \in U \rightarrow \mathbb{R}^n$, $p \mapsto x = 0$. Let $\text{supp } f \subset U$, $f(p) = 1$. If $X_p = 0$, then $\omega(X)(p) = \omega(f^2 X)(p) = (fX^i)(0)\omega(f\partial/\partial x^i) = 0$, since $X^i(0) = 0$. \square

Thus, for any $p \in M$ a covector $\omega_p \in T_p^*$ is defined through

$$\omega(X)(p) = \langle \omega_p, X_p \rangle.$$

In any chart we then have

$$\omega(X) = \omega_i(x)X^i(x), \quad \text{i.e.} \quad \omega = \omega_i(x)dx^i$$

($dx^i : X \mapsto X^i$, locally) with smooth components $\omega_i(x)$. A word of caution: While every covector $\omega \in T_p^*$ is of the form $\omega = df$ (i.e. pointwise), this is not true for a 1-form ω (in fact, not even locally). Indeed $\omega_i = f_{,i}$ implies $\omega_{i,j} = \omega_{j,i}$, which is false as a rule for arbitrary components $\omega_i(x)$.

Tensor fields

Example: A tensor field R of type $\binom{1}{2}$ is a function $R(\omega, X, Y)$ of: ω (1-form), X, Y (vector fields), taking values in \mathcal{F} , which is \mathcal{F} -linear in each variable. A tensor field can also be viewed as a function

$$R : p \in M \mapsto R_p : \text{tensor on } T_p ,$$

which is smooth in terms of its components: In any chart we have

$$R(\omega, X, Y) = R^i{}_{jk}(x)\omega_i(x)X^j(x)Y^k(x)$$

with smooth components $R^i{}_{jk}(x)$. They transform according to (1.5, 1.4) under coordinate changes.

Tangent map

($\varphi : M \rightarrow \bar{M}$ differentiable)

1-forms: $\bar{\omega} \mapsto \varphi^*\bar{\omega}$. The 1-form $\varphi^*\bar{\omega}$ on M is defined by (1.6) and \mathcal{F} -linearity. Equivalently,

$$(\varphi^*\bar{\omega})_p = \varphi^*\bar{\omega}_{\varphi(p)} .$$

Let henceforth φ be a diffeomorphism.

Vector fields: $X \mapsto \varphi_*X$, a vector field on \bar{M} :

$$(\varphi_*X)\bar{f} = [X(\bar{f} \circ \varphi)] \circ \varphi^{-1} ,$$

hence $(\varphi_*X)_{\bar{p}} = \varphi_*X_{\varphi^{-1}(\bar{p})}$. One readily verifies

$$\varphi_*(fX) = (f \circ \varphi^{-1})\varphi_*X , \quad \varphi_*[X, Y] = [\varphi_*X, \varphi_*Y] .$$

Tensor fields: $\bar{R} \mapsto \varphi^*\bar{R}$, ($\varphi_* = \varphi^{*-1}$), e.g. \bar{R} of type $\binom{1}{1}$:

$$(\varphi^*\bar{R})(\omega, X) = \bar{R}(\varphi^{*-1}\omega, \varphi_*X) \circ \varphi ,$$

resp.

$$(\varphi^*\bar{R})_p = \varphi^*\bar{R}_{\varphi(p)} , \tag{1.12}$$

i.e. φ^* acts pointwise on the tensors of the field.

Flows and generating vector fields

A **flow** is a 1-parameter group of diffeomorphisms $\varphi_t : M \rightarrow M$, ($t \in \mathbb{R}$) with

$$\varphi_t \circ \varphi_s = \varphi_{t+s} .$$

In particular $\varphi_0 = \text{id}$. Moreover the **orbits** (or integral curves) of any point $p \in M$

$$t \mapsto \varphi_t(p) \equiv \gamma(t)$$

shall be differentiable. A flow determines a **vector field** X by means of

$$Xf = \left. \frac{d}{dt}(f \circ \varphi_t) \right|_{t=0}, \quad (1.13)$$

i.e. $X_p = \left. \frac{d}{dt}\gamma(t) \right|_{t=0} = \dot{\gamma}(0),$

where $\dot{\gamma}(0)$ is the tangent vector to γ at the point $p = \gamma(0)$. At the point $\gamma(t)$ we then have

$$\dot{\gamma}(t) = \left. \frac{d}{dt}\varphi_t(p) = \frac{d}{ds}(\varphi_s \circ \varphi_t)(p) \right|_{s=0} = X_{\varphi_t(p)}.$$

i.e. $\gamma(t)$ solves the ordinary differential equation (ODE)

$$\dot{\gamma}(t) = X_{\gamma(t)}, \quad \gamma(0) = p. \quad (1.14)$$

The generating vector field thus determines the flow uniquely. (In general a vector field may fail to generate a flow, because (1.14) may not admit global solutions (i.e. for all $t \in \mathbb{R}$). For most purposes “local flows” suffice, though.)

Remark. A vector field Y is pushed forward under φ_{t*} according to

$$\frac{d}{dt}\varphi_{t*}Y = -\varphi_{t*}[X, Y]. \quad (1.15)$$

Indeed, by (1.7) we have

$$\frac{d}{dt}\varphi_{t*}Y = \left. \frac{d}{ds}\varphi_{t+s*}Y \right|_{s=0} = \varphi_{t*}\left(\left. \frac{d}{ds}\varphi_{s*}Y \right|_{s=0}\right)$$

and we see that the case $t = 0$ suffices:

$$\begin{aligned} \left. \frac{d}{dt}(\varphi_{t*}Y)f \right|_{t=0} &= \left. \frac{d}{dt}Y(f \circ \varphi_t) \circ \varphi_{-t} \right|_{t=0} \\ &= Y\left(\left. \frac{d}{dt}f \circ \varphi_t \right|_{t=0}\right) + \left. \frac{d}{dt}((Yf) \circ \varphi_{-t}) \right|_{t=0} = YXf - XYf. \end{aligned}$$

On the meaning of $[X, Y] = 0$

Let φ_t be the flow generated by X . If $[X, Y] = 0$, then

$$\varphi_{t*}Y = Y, \quad \text{i.e.} \quad Y_{\varphi_t(p)} = \varphi_{t*}Y_p, \quad (1.16)$$

by (1.15). Let now ψ_s be the flow generated by Y . By (1.16) we have

$$\frac{d}{ds}\varphi_t(\psi_s(p)) = \varphi_{t*}Y_{\psi_s(p)} = Y_{\varphi_t(\psi_s(p))},$$

i.e. $\varphi_t(\psi_s(p))$ satisfies the ODE and the initial value for $\psi_s(\varphi_t(p))$. Hence they are the same. The result is:

$$[X, Y] = 0 \iff \varphi_t \circ \psi_s = \psi_s \circ \varphi_t \quad (1.17)$$

(if X, Y generate global flows). Actually, the above proves “ \Rightarrow ”, the other direction being simpler.

1.3. The Lie derivative

The derivative of a vector field V rests on the comparison of V_p and $V_{p'}$ at nearby points p, p' . Since $V_p \in T_p$, $V_{p'} \in T_{p'}$ belong to different spaces their difference can be taken only after $V_{p'}$ has been transported to T_p . This can be achieved by means of the tangent map φ_* (Lie transport).

The **Lie derivative** $L_X R$ of a tensor field R in direction of a vector field X is defined by

$$L_X R = \left. \frac{d}{dt} \varphi_t^* R \right|_{t=0} \quad (1.18)$$

or, somewhat more explicitly, cf. (1.12),

$$(L_X R)_p = \left. \frac{d}{dt} \varphi_t^* R_{\varphi_t(p)} \right|_{t=0} .$$

Here, φ_t is the (local) flow generated by X , whence $\varphi_t^* R_{\varphi_t(p)}$ is a tensor on T_p depending on it. In order to express L_X in components we write φ_t in a chart

$$\varphi_t : x \mapsto \bar{x}(t, x)$$

and linearize in small t :

$$\bar{x}^i = x^i + tX^i(x) + \dots , \quad x^i = \bar{x}^i - tX^i(\bar{x}) + \dots ,$$

hence

$$\frac{\partial^2 \bar{x}^i}{\partial x^k \partial t} = - \frac{\partial^2 x^i}{\partial \bar{x}^k \partial t} = X^i_{,k} \quad (1.19)$$

at $t = 0$. As an example, let R be of type $\binom{1}{1}$. By (1.9) we then have

$$(\varphi_t^* R)^i_j(x) = R^\alpha_\beta(\bar{x}) \frac{\partial x^i}{\partial \bar{x}^\alpha} \frac{\partial \bar{x}^\beta}{\partial x^j} .$$

Taking a derivative w.r.t. t at $t = 0$ yields:

$$(L_X R)^i_j = R^i_{j,k} X^k - R^\alpha_j X^i_{,\alpha} + R^i_\beta X^\beta_{,j} . \quad (1.20)$$

Properties of L_X

- (a) L_X is a linear map from tensor field to tensor fields of the same type
- (b) $L_X(\text{tr} T) = \text{tr}(L_X T)$, (tr any trace)
- (c) $L_X(T \otimes S) = (L_X T) \otimes S + T \otimes (L_X S)$
- (d) $L_X f = Xf$, ($f \in \mathcal{F}$)
- (e) $L_X Y = [X, Y]$, (Y : vector field)
- (f) $(L_X \omega)(Y) = X\omega(Y) - \omega([X, Y])$, (ω 1-form)

Proof. (a) follows from (1.18), (b,c) from (1.8), (d) from (1.13) and (e) from (1.15) with $\varphi_t^* = \varphi_{-t*}$. Finally, (f) follows from (a-e) by

$$(L_X \omega)(Y) = \text{tr}(L_X \omega \otimes Y) = \text{tr} L_X(\omega \otimes Y) - \text{tr} \omega \otimes L_X Y = X\omega(Y) - \omega([X, Y]) .$$

□

Alternate definition of L_X : For a given vector field X the properties (a–e) (which do not refer to flows) determine $L_X R$ uniquely for any tensor field R . In particular, this definition agrees with (1.18).

Proof. As noted, (f) follows from (a–e). By (c) $L_X R$ is defined for tensors of all types. \square

Further properties of L_X

L_X is linear in X

$$L_{X+Y} = L_X + L_Y, \quad L_{\lambda X} = \lambda L_X, \quad (\lambda \in \mathbb{R})$$

(but not \mathcal{F} -linear, $L_{fX} \neq fL_X$, as a rule!) and

$$L_{[X,Y]} = L_X L_Y - L_Y L_X.$$

Proof. The r.h.s. of the last equation satisfies (a–c) and agrees with the l.h.s. on $f \in \mathcal{F}$, as well as on vector fields Z , the latter because of (1.11). \square

1.4. Differential forms

A p -form Ω is a totally antisymmetric tensor field of type $\binom{0}{p}$:

$$\Omega(X_{\pi(1)}, \dots, X_{\pi(p)}) = (\text{sgn } \pi) \Omega(X_1, \dots, X_p)$$

for any permutation π of $\{1, \dots, p\}$: $\pi \in S_p$, with $\text{sgn } \pi$ being its parity. In particular, $\Omega \equiv 0$ for $p > \dim M$. Any tensor field of type $\binom{0}{p}$ can be antisymmetrized by means of the operation \mathcal{A} :

$$(\mathcal{A}T)(X_1, \dots, X_p) = \frac{1}{p!} \sum_{\pi \in S_p} (\text{sgn } \pi) T(X_{\pi(1)}, \dots, X_{\pi(p)}). \quad (1.21)$$

We have $\mathcal{A}^2 = \mathcal{A}$. The **exterior product** of a p_1 -form Ω^1 with a p_2 -form Ω^2 is the $(p_1 + p_2)$ -form

$$\Omega^1 \wedge \Omega^2 = \frac{(p_1 + p_2)!}{p_1! p_2!} \mathcal{A}(\Omega^1 \otimes \Omega^2). \quad (1.22)$$

Properties:

$$\begin{aligned} \Omega^1 \wedge \Omega^2 &= (-1)^{p_1 p_2} \Omega^2 \wedge \Omega^1 \\ \Omega^1 \wedge (\Omega^2 \wedge \Omega^3) &= (\Omega^1 \wedge \Omega^2) \wedge \Omega^3 = \frac{(p_1 + p_2 + p_3)!}{p_1! p_2! p_3!} \mathcal{A}(\Omega^1 \otimes \Omega^2 \otimes \Omega^3) \end{aligned}$$

Components: In a (local) basis of 1-forms (e^1, \dots, e^n)

$$\begin{aligned} \Omega &= \Omega_{i_1 \dots i_p} e^{i_1} \otimes \dots \otimes e^{i_p} = \mathcal{A}\Omega \\ &= \Omega_{i_1 \dots i_p} \mathcal{A}(e^{i_1} \otimes \dots \otimes e^{i_p}) \\ &= \Omega_{i_1 \dots i_p} \frac{1}{p!} e^{i_1} \wedge \dots \wedge e^{i_p} \\ &= \Omega_{i_1 \dots i_p} e^{i_1} \wedge \dots \wedge e^{i_p} \quad (\text{when restricting the sum to } i_1 < \dots < i_p). \end{aligned} \quad (1.23)$$

Examples: For 1-forms A, B we have

$$(A \wedge B)_{ik} = A_i B_k - A_k B_i .$$

For a 2-form A and 1-form B ,

$$(A \wedge B)_{ikl} = A_{ik} B_l + A_{kl} B_i + A_{li} B_k , \quad (1.24)$$

because

$$A \wedge B = A_{ik} B_l \frac{1}{2} e^i \wedge e^k \wedge e^l = \underbrace{(A_{ik} B_l + \text{zykl.})}_{(A \wedge B)_{ikl}} \frac{1}{6} e^i \wedge e^k \wedge e^l ,$$

since the bracket is totally antisymmetric.

The exterior derivative of a differential form

The derivative df of a 0-form $f \in \mathcal{F}$ is the 1-form $df(X) = Xf$: the argument X acts as a derivation. The derivative $d\Omega$ of a 1-form Ω is

$$d\Omega(X_1, X_2) = X_1\Omega(X_2) - X_2\Omega(X_1) - \Omega([X_1, X_2]) .$$

The last term ensures that $d\Omega$ is a 2-form, being \mathcal{F} -linear in X_1, X_2 :

$$\begin{aligned} d\Omega(fX_1, X_2) &= fX_1\Omega(X_2) - X_2\Omega(fX_1) - \Omega([fX_1, X_2]) \\ &= fX_1\Omega(X_2) - ((X_2f)\Omega(X_1) + fX_2\Omega(X_1)) - \Omega(f[X_1, X_2] + (X_2f)X_1) \\ &= fd\Omega(X_1, X_2) . \end{aligned} \quad (1.25)$$

On $\Omega \wedge f = f\Omega$ the product rule $d(\Omega \wedge f) = d\Omega \wedge f - \Omega \wedge df$ applies, since

$$\begin{aligned} d(\Omega \wedge f)(X_1, X_2) &= X_1(f\Omega)(X_2) - X_2(f\Omega)(X_1) - (f\Omega)([X_1, X_2]) \\ &= fd\Omega(X_1, X_2) - \Omega(X_1)f(X_2) + \Omega(X_2)f(X_1) . \end{aligned} \quad (1.26)$$

Moreover we have $d^2f = 0$, because

$$\begin{aligned} d^2f(X_1, X_2) &= X_1df(X_2) - X_2df(X_1) - df([X_1, X_2]) \\ &= X_1X_2f - X_2X_1f - [X_1, X_2]f = 0 . \end{aligned} \quad (1.27)$$

The generalization of the definition to p -forms Ω is

$$\begin{aligned} d\Omega(X_1, \dots, X_{p+1}) &= \sum_{i=1}^{p+1} (-1)^{i-1} X_i \Omega(X_1, \dots, \widehat{X}_i, \dots, X_{p+1}) \\ &\quad + \sum_{i < j} (-1)^{i+j} \Omega([X_i, X_j], X_1, \dots, \widehat{X}_i, \dots, \widehat{X}_j, \dots, X_{p+1}) , \end{aligned} \quad (1.28)$$

where $\widehat{}$ denotes omission. Analogously to (1.25-1.27) one shows the

Properties of d

- (a) d is a linear map from p -forms to $(p+1)$ -forms
- (b) $d(\Omega^1 \wedge \Omega^2) = d\Omega^1 \wedge \Omega^2 + (-1)^{p_1} \Omega^1 \wedge d\Omega^2$

- (c) $d^2 = 0$, i.e. $d(d\Omega) = 0$
(d) $df(X) = Xf$, ($f \in \mathcal{F}$)

Alternate definition of d : By means of (a–d), hence without reference to commutators.

Proof. We need to show that d is defined on all p -forms Ω . By (1.23) we have w.r.t. a coordinate basis

$$\Omega = \frac{1}{p!} \Omega_{i_1 \dots i_p} dx^{i_1} \wedge \dots \wedge dx^{i_p}, \quad (1.29)$$

hence

$$d\Omega = \frac{1}{p!} d\Omega_{i_1 \dots i_p} \wedge dx^{i_1} \wedge \dots \wedge dx^{i_p}.$$

□

Components: ($_{,i} = \partial/\partial x^i$)

$$\begin{aligned} p!d\Omega &= \Omega_{i_1 i_2 \dots i_p, i_0} dx^{i_0} \wedge \dots \wedge dx^{i_p} \\ &= -\Omega_{i_0 i_2 \dots i_p, i_1} dx^{i_0} \wedge \dots \wedge dx^{i_p} \\ &= (-1)^k \Omega_{i_0 \dots \hat{i}_k \dots i_p, i_k} dx^{i_0} \wedge \dots \wedge dx^{i_p}, \quad (k = 0, \dots, p), \\ d\Omega &= \underbrace{\sum_{k=0}^p (-1)^k \Omega_{i_0 \dots \hat{i}_k \dots i_p, i_k}}_{(d\Omega)_{i_0 \dots i_p}} \frac{1}{(p+1)!} dx^{i_0} \wedge \dots \wedge dx^{i_p}. \end{aligned} \quad (1.30)$$

Examples:

$$p = 1 : \quad (d\Omega)_{ik} = \Omega_{k,i} - \Omega_{i,k}, \quad (1.31)$$

$$p = 2 : \quad (d\Omega)_{ikl} = \Omega_{ik,l} + \Omega_{kl,i} + \Omega_{li,k}. \quad (1.32)$$

Further properties: For any map $\varphi : M \rightarrow N$,

$$\varphi^* \circ d = d \circ \varphi^*. \quad (1.33)$$

Proof. Because of (1.29, 1.8) and property (b) it suffices to verify (1.33) on:

0-forms \bar{f} : (1.33) is identical to (1.6);

1-forms, which are differentials $d\bar{f}$: because of (c) we have

$$(\varphi^* \circ d)(d\bar{f}) = 0, \quad (d \circ \varphi^*)(d\bar{f}) = d(\varphi^* \circ d\bar{f}) = (d^2 \circ \varphi^*)(\bar{f}) = 0.$$

□

Setting $\varphi = \varphi_t$ (the flow generated by X) and forming $d/dt|_{t=0}$, one obtains the infinitesimal version of (1.33):

$$L_X \circ d = d \circ L_X. \quad (1.34)$$

Definition. A p -Form ω with

- $\omega = d\eta$ is **exact**;
- $d\omega = 0$ is **closed**.

The implication “ ω exact $\Rightarrow \omega$ closed” holds true, but the converse generally not. A local converse is the Poincaré lemma:

Lemma. Let $G \subset M$ be an open domain in a “star-shaped” chart. Any point in the chart is connected to the origin by a straight line lying in the chart. Let ω be a p -form with $d\omega = 0$ in G . Then there exists a $(p - 1)$ -form η such that

$$\omega = d\eta .$$

Proof. See p. 15.

Remark. Obviously, η is not unique, since “gauge transformations” $\eta \rightarrow \eta + d\rho$, with ρ any $(p - 2)$ -form, leave $d\eta$ unchanged.

The integral of an n -form

Let an **orientation** be given on M : an atlas of “positively oriented” charts, i.e.

$$\det \left(\frac{\partial \bar{x}^i}{\partial x^j} \right) > 0 \tag{1.35}$$

for any change of coordinates. (Not every manifold is orientable; example: the Möbius strip). An n -form ω , ($n = \dim M$),

$$\omega = \omega_{i_1 \dots i_n} \frac{1}{n!} dx^{i_1} \wedge \dots \wedge dx^{i_n} = \underbrace{\omega_{1 \dots n}}_{\omega(x)} dx^1 \wedge \dots \wedge dx^n$$

is determined by the single component $\omega(x)$; under a change of coordinates it transforms as

$$\bar{\omega}(\bar{x}) = \bar{\omega}_{1 \dots n} = \omega_{i_1 \dots i_n} \frac{\partial x^{i_1}}{\partial \bar{x}^1} \dots \frac{\partial x^{i_n}}{\partial \bar{x}^n} = \omega(x) \det \left(\frac{\partial x^i}{\partial \bar{x}^j} \right) . \tag{1.36}$$

The **integral** of an n -form is defined as follows. If $\text{supp } \omega$ is contained in a (positive) chart, we set

$$\int_M \omega = \int dx^1 \dots dx^n \omega(x^1 \dots x^n) .$$

For $\text{supp } \omega$ in the intersection of two charts, $\int \omega$ is independent of the one used by (1.35, 1.36) and

$$\int dx^1 \dots dx^n \omega(x) = \int d\bar{x}^1 \dots d\bar{x}^n \omega(x) \left| \det \left(\frac{\partial x^i}{\partial \bar{x}^j} \right) \right| .$$

For arbitrary ω of compact support we define

$$\int_M \omega = \sum_k \int h_k \omega . \tag{1.37}$$

Here $\{h_k\}$ is a partition of unity on M :

$$h_k \in \mathcal{F} , \quad h_k \geq 0 , \quad \sum_k h_k = 1$$

such that each $\text{supp } h_k$ is contained in some chart (such partitions do exist). The independence of (1.37) on the choice of the partition is seen by considering the refinement $\{h_k g_l\}$ of two partitions $\{h_k\}, \{g_l\}$.

Remark. Upon reversing the orientation, $\int_M \omega$ changes sign.

The Stokes Theorem

A (n -dimensional) **manifold with boundary** is locally homeomorphic to $\mathbb{R}^{n-} = \{(x^1 \dots x^n) \in \mathbb{R}^n \mid x^1 \leq 0\}$:

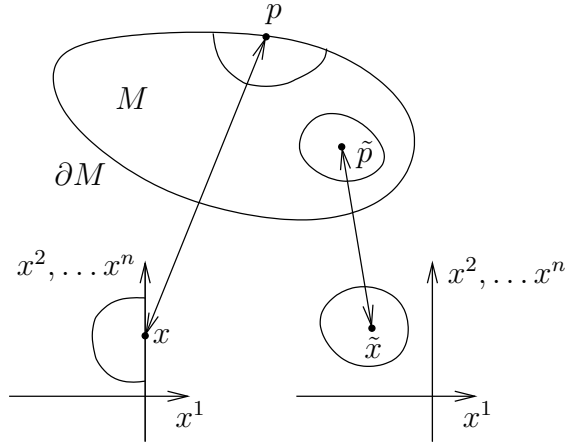

The boundary ∂M consists of those $p \in M$, whose image x in some (and hence any) chart satisfies $x^1 = 0$.

Orientation of the boundary: an orientation on M induces one on ∂M : If $(x^1 \dots x^n)$ is a positive chart for $U \subset M$, then $(x^2 \dots x^n)$ is one on $\partial M \cap U$. (Show the consistency of this definition.)

Stokes Theorem: Let M , ($\dim M = n$), be an oriented manifold with boundary. Then, for any $(n-1)$ -form ω :

$$\int_M d\omega = \int_{\partial M} \omega . \quad (1.38)$$

Proof. Let $\{h_k\}$ be a partition of unity on M . We decompose $\omega = \sum_k h_k \omega$. We then need to prove (1.38) in two special cases:

(a) $\text{supp } \omega$ lies in a chart without boundary. Then (cf. (1.30))

$$\int_M d\omega = \int dx^1 \dots dx^n \sum_{k=1}^n (-1)^{k-1} \omega_{1 \dots \hat{k} \dots n, k} = 0 .$$

(b) $\text{supp } \omega$ lies in a chart with boundary. Then

$$\begin{aligned} \int_M d\omega &= \int dx^1 \dots dx^n \sum_{k=1}^n (-1)^{k-1} \omega_{1 \dots \hat{k} \dots n, k} = \int dx^1 \dots dx^n \omega_{2 \dots n, 1} \\ &= \int dx^2 \dots dx^n \omega(0, x^2, \dots, x^n) = \int_{\partial M} \omega , \end{aligned}$$

since $(x^2 \dots x^n)$ is a positively oriented chart of ∂M . □

The inner product of a p -form

Let X be a vector field on M . For any p -form Ω let

$$(i_X \Omega)(X_1, \dots, X_{p-1}) = \Omega(X, X_1, \dots, X_{p-1}) , \quad (1.39)$$

(= 0 if $p = 0$).

Properties

- (a) i_X is a linear map from p -forms to $(p - 1)$ -forms
- (b) $i_X(\Omega^1 \wedge \Omega^2) = (i_X\Omega^1) \wedge \Omega^2 + (-1)^{p_1}\Omega^1 \wedge i_X\Omega^2$
- (c) $i_X^2 = 0$
- (d) $i_X df = Xf, (f \in \mathcal{F})$
- (e) $L_X = i_X \circ d + d \circ i_X$

Proof. (a–d) are straightforward. It suffices to verify (e) on:

0-forms f : both sides equal Xf .

1-form, which are differentials df : both sides equal $d(Xf)$ because of (1.34). \square

Applications:

1) The Gauss Theorem:

The manifold M is oriented iff there is an n -form η with $\eta_p \neq 0$ for all $p \in M$ (“volume form”). Let X be a vector field. Then $d(i_X\eta)$ is a n -form and a function $\text{div}_\eta X \in \mathcal{F}$ is defined through

$$(\text{div}_\eta X)\eta = d(i_X\eta) \quad (1.40)$$

(also = $L_X\eta$, because of (e)). The Stokes Theorem immediately implies the **Gauss Theorem**:

$$\int_M (\text{div}_\eta X)\eta = \int_{\partial M} i_X\eta.$$

In a chart:

$$\begin{aligned} (i_X\eta)_{i_2\dots i_n} &= X^a \eta_{a i_2\dots i_n} \\ d(i_X\eta)_{1\dots n} &= \sum_{k=1}^n (-1)^{k-1} \underbrace{(X^a \eta_{a 1\dots \hat{k}\dots n})}_{(-1)^{k-1} X^k \eta_{1\dots n}},_k = (X^k \eta_{1\dots n}),_k \end{aligned}$$

hence, setting again $\eta(x) \equiv \eta_{1\dots n}(x)$,

$$\text{div}_\eta X = \frac{1}{\eta} (\eta X^k),_k. \quad (1.41)$$

For the integral $\int_{\partial D} i_X\eta$ (only boundary charts contribute, see figure on p. 14) we obtain:

$$\int_{\partial M} i_X\eta = \int dx^2 \dots dx^n (i_X\eta)_{2\dots n}(0, x^2, \dots, x^n) = \int dx^2 \dots dx^n (\eta X^1)(0, x^2, \dots, x^n)$$

because (x^2, \dots, x^n) is a positively oriented chart of ∂M .

2) **Proof** of the Poincaré lemma: By using a chart we may assume $U \subset \mathbb{R}^n$ and thus identify $T_x \cong \mathbb{R}^n$. We shall construct a map T from p - to $(p - 1)$ -forms on U with

$$(T \circ d + d \circ T)\omega = \omega$$

(ω : arbitrary p -form). For $d\omega = 0$ this implies $d\eta = \omega$ for $\eta = T\omega$, as claimed. Construction of T :

$$(T\omega)_x = \int_0^1 t^{p-1} (i_X \omega)_{tx} dt, \quad (x \in U),$$

where X is the vector field with components $X^i(x) = x^i$. Then (e) implies

$$[(Td + dT)\omega]_x = \int_0^1 t^{p-1} (L_X \omega)_{tx} dt. \quad (1.42)$$

Here $L_X \omega = (x\nabla)\omega + p\omega$ because by (1.20) we have

$$(L_X \omega)_{i_1 \dots i_p} = x^k \omega_{i_1 \dots i_p, k} + \sum_{j=1}^p \omega_{i_1 \dots k \dots i_p} \underbrace{X^k}_{\delta^k_{i_j}} .$$

\uparrow
 j -th position

Moreover we have $[(x\nabla)\omega]_{tx} = tx(\nabla\omega)_{tx} = t \frac{d}{dt} \omega_{tx}$, hence

$$t^{p-1} (L_X \omega)_{tx} = t^p \frac{d}{dt} \omega_{tx} + p t^{p-1} \omega = \frac{d}{dt} (t^p \omega_{tx})$$

and (1.42) equals ω_x . □

2. Affine connections

2.1. Parallel transport and covariant derivative

Definition: Any curve γ in M is equipped with a **parallel transport** of vectors:

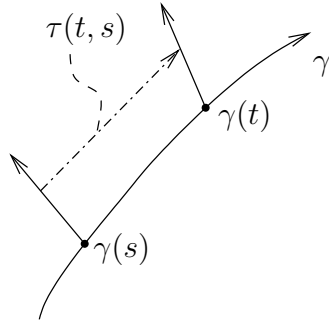

$$\tau(t, s) : T_{\gamma(s)} \rightarrow T_{\gamma(t)}$$

is a linear map with

$$\tau(t, t) = 1, \quad \tau(t, s)\tau(s, r) = \tau(t, r). \quad (2.1)$$

In any chart we shall have

$$\left. \frac{\partial}{\partial t} \tau^i_k(t, s) \right|_{t=s} = -\Gamma^i_{lk}(\gamma(s)) \dot{\gamma}^l(s). \quad (2.2)$$

Remarks. 1) The Lie transport φ_{t*} along an orbit of Y is *not* of the form (2.2): Infinitesimally it is

$$\left. \frac{d}{dt} (\varphi_{t*})^i_k \right|_{t=0} = Y^i_{,k},$$

by (1.19), which is not expressible solely by its tangent vector $\dot{\gamma}^l(0) = Y^l(x)$.

2) A parallel transported vector $X(t) = \tau(t, s)X(s) \in T_{\gamma(t)}$ solves, in a chart, the differential equation

$$\dot{X}^i(s) = -\Gamma^i_{lk}(\gamma(s)) \dot{\gamma}^l(s) X^k(s). \quad (2.3)$$

The \dot{X}^i are not the components of a vector, hence the **Christoffel symbols** $\Gamma^i_{lk}(x)$ not those of a tensor (s. below).

3) Equation (2.3) states, that the \dot{X}^i are linear in $\dot{\gamma}^l$, X^k . Because of this property (which is independent of the chart) $\tau(t, s)$ does not depend on the parameterization of γ (but also not just on the endpoints $\gamma(s)$, $\gamma(t)$).

4) Because of (2.1) we also have

$$\left. \frac{\partial}{\partial s} \tau^i_k(t, s) \right|_{s=t} = \Gamma^i_{lk}(\gamma(t)) \dot{\gamma}^l(t). \quad (2.4)$$

5) Upon changing chart,

$$\bar{\tau}^i_k(t, s) = \tau^p_q(t, s) \left. \frac{\partial \bar{x}^i}{\partial x^p} \right|_{\gamma(t)} \left. \frac{\partial x^q}{\partial \bar{x}^k} \right|_{\gamma(s)}.$$

Applying $\left. \frac{\partial}{\partial s} \right|_{s=t}$ and (2.4) implies

$$\bar{\Gamma}^i_{lk} \dot{\gamma}^l = \Gamma^p_{rq} \underbrace{\dot{\gamma}^r}_{\frac{\partial x^r}{\partial \bar{x}^l} \dot{\gamma}^l} \frac{\partial \bar{x}^i}{\partial x^p} \frac{\partial x^q}{\partial \bar{x}^k} + \delta^p_q \frac{\partial \bar{x}^i}{\partial x^p} \frac{\partial^2 x^q}{\partial \bar{x}^k \partial \bar{x}^l} \dot{\gamma}^l,$$

hence:

$$\bar{\Gamma}^i_{lk}(\bar{x}) = \Gamma^p_{rq}(x) \frac{\partial \bar{x}^i}{\partial x^p} \frac{\partial x^q}{\partial \bar{x}^k} \frac{\partial x^r}{\partial \bar{x}^l} + \frac{\partial \bar{x}^i}{\partial x^p} \frac{\partial^2 x^p}{\partial \bar{x}^k \partial \bar{x}^l}. \quad (2.5)$$

Conversely, a field $\Gamma^i_{lk}(x)$ with this transformation law determines a parallel transport along any curve $\gamma(t)$ by means of the differential equation (2.2).

The **parallel transport** is extended to tensors by means of the requirements

$$\begin{aligned}\tau(t, s)(T \otimes S) &= (\tau(t, s)T) \otimes (\tau(t, s)S) , \\ \tau(t, s)(\text{tr } T) &= \text{tr}(\tau(t, s)T) , \quad (\text{tr} = \text{any trace}) \\ \tau(t, s)c &= c , \quad (c \in \mathbb{R}) ,\end{aligned}$$

so e.g. for a covector ω

$$\langle \tau(t, s)\omega, \tau(t, s)X \rangle_{\gamma(t)} = \langle \omega, X \rangle_{\gamma(s)}$$

and for a tensor T of type $\binom{1}{1}$

$$(\tau(t, s)T)(\tau(t, s)\omega, \tau(t, s)X) = T(\omega, X) . \quad (2.6)$$

In components:

$$(\tau(t, s)T)^i_k = T^\alpha_\beta \tau^\alpha_i(t, s) \tau_k^\beta(t, s)$$

with (τ_i^k) the inverse-transposed of (τ^i_k) .

The **covariant derivative** ∇_X (X : vector field, T : tensor field) associated to τ is

$$(\nabla_X T)_p = \left. \frac{d}{dt} \tau(0, t) T_{\gamma(t)} \right|_{t=0} , \quad (2.7)$$

where $\gamma(t)$ is any curve through $p = \gamma(0)$ with $\dot{\gamma}(0) = X_p$.

Properties

- (a) ∇_X is a linear map from tensor fields to tensor fields of the same type
- (b) $\nabla_X f = Xf$
- (c) $\nabla_X(\text{tr } T) = \text{tr}(\nabla_X T)$, (tr = any trace)
- (d) $\nabla_X(T \otimes S) = \nabla_X T \otimes S + T \otimes \nabla_X S$

They follow from the corresponding properties of $\tau(t, s)$. For a 1-form ω we have

$$\begin{aligned}(\nabla_X \omega)(Y) &= \text{tr}(\nabla_X \omega \otimes Y) = \text{tr} \nabla_X(\omega \otimes Y) - \text{tr}(\omega \otimes \nabla_X Y) \\ &= \nabla_X \text{tr}(\omega \otimes Y) - \omega(\nabla_X Y) = X\omega(Y) - \omega(\nabla_X Y) .\end{aligned} \quad (2.8)$$

We write the general differentiation rule for a tensor field of type $\binom{1}{1}$

$$(\nabla_X T)(\omega, Y) = XT(\omega, Y) - T(\nabla_X \omega, Y) - T(\omega, \nabla_X Y) . \quad (2.9)$$

It is obvious from (2.8, 2.9) and (a–d) that the operation ∇_X is completely determined by its action on vector fields Y . The latter is called an **affine connection**:

- (i) $\nabla_X Y$ is a vector field depending linearly on X, Y
- (ii) $\nabla_X Y$ is \mathcal{F} -linear in X :

$$\nabla_{fX} Y = f \nabla_X Y , \quad (f \in \mathcal{F}) . \quad (2.10)$$

$$(iii) \nabla_X(fY) = f\nabla_X Y + (Xf)Y$$

Proof. (iii) is a special case of (d); (ii) is verified by means of its representation in a chart

$$(\nabla_X Y)^i = \left. \frac{d}{dt} \tau^i_k(0, t) Y^k(x^1 + tX^1 + O(t^2), \dots) \right|_{t=0} = (Y^i_{,l} + \Gamma^i_{lk} Y^k) X^l \quad (2.11)$$

where we used (2.4) and $\gamma^l(t) = x^l + tX^l + O(t^2)$. Incidentally, this shows that any curve γ conforming with (2.7) yields the same result. \square

Conversely any affine connection entails a parallel transport (bijectively): In any chart with coordinate basis (e_1, \dots, e_n) we have

$$\begin{aligned} \nabla_X Y &= \nabla_X(Y^i e_i) = (XY^i) e_i + Y^k (\nabla_X e_k) \\ &= Y^i_{,l} X^l e_i + Y^k X^l \nabla_{e_l} e_k \end{aligned}$$

which, after defining

$$\Gamma^i_{lk}(x) = \langle e^i, \nabla_{e_l} e_k \rangle, \quad (2.12)$$

agrees with (2.11). One can show that (2.12) transforms according to (2.5), and hence defines a parallel transport.

The covariant derivative ∇

Example: By (2.9) $(\nabla_X T)(\omega, Y)$ is \mathcal{F} -linear in all 3 variables ω, Y, X , and this defines a tensor field of type $\binom{1}{2}$ through

$$(\nabla T)(\omega, Y, X) = (\nabla_X T)(\omega, Y).$$

The notation

$$T^i_{k;l} \equiv (\nabla T)^i_{kl}$$

for its components is customary, but a bit dangerous: for fixed i, k , $T^i_{k;l}$ is not determined by the sole component $T^i_k(x)$! Examples:

$$\begin{aligned} Y^i_{;k} &= Y^i_{,k} + \Gamma^i_{kl} Y^l, \\ \omega_{i;k} &= \omega_{i,k} - \omega_l \Gamma^l_{ki}, \\ T^i_{k;r} &= T^i_{k,r} + \Gamma^i_{rl} T^l_k - \Gamma^l_{rk} T^i_l. \end{aligned}$$

2.2. Torsion and curvature

Let an affine connection be given on M , let X, Y, Z be vector fields. **Definitions:**

$$\begin{aligned} T(X, Y) &= \nabla_X Y - \nabla_Y X - [X, Y], \\ R(X, Y) &= \nabla_X \nabla_Y - \nabla_Y \nabla_X - \nabla_{[X, Y]}. \end{aligned}$$

To begin with, the **torsion** $T(X, Y)$ is a vector field and the **curvature** $R(X, Y)$ a linear map from tensor fields to tensor fields of the same type. They are both antisymmetric in X, Y . Moreover, they have however tensorial **character**:

- $T(X, Y)$ is \mathcal{F} -linear in X, Y and thus defines a tensor of type $\binom{1}{2}$ through

$$(\omega, X, Y) \mapsto \langle \omega, T(X, Y) \rangle,$$

called **torsion tensor**.

- The vector field $R(X, Y)Z$ is \mathcal{F} -linear in X, Y, Z . Therefore R determines a tensor of type $\binom{1}{3}$ (**curvature or Riemann tensor**):

$$\langle \omega, Z, X, Y \rangle \mapsto \langle \omega, R(X, Y)Z \rangle \equiv R^i{}_{jkl} \omega_i Z^j X^k Y^l .$$

Proof. We have

$$[fX, Y] = f[X, Y] - (Yf)X .$$

Thus

$$\begin{aligned} T(fX, Y) &= f\nabla_X Y - \underline{f\nabla_Y X} - \underline{(Yf)X} - f[X, Y] + \underline{(Yf)X} = fT(X, Y) , \\ R(fX, Y) &= f\nabla_X \nabla_Y \underline{-\nabla_Y f \nabla_X} - \underline{f\nabla_{[X, Y]}} + \underline{(Yf)\nabla_X} = fR(X, Y) \\ &\quad - \underline{f\nabla_Y \nabla_X} - \underline{(Yf)\nabla_X} \end{aligned}$$

with cancellation of the underlined terms. The \mathcal{F} -linearity in Z of $R(X, Y)Z$ follows from (d) of the next proposition. \square

Proposition:

- (a) $R(X, Y)f = 0$
- (b) $R(X, Y)(S \otimes T) = (R(X, Y)S) \otimes T + S \otimes (R(X, Y)T)$
- (c) $\text{tr } R(X, Y)T = R(X, Y) \text{tr } T$, (tr without contraction involving X or Y)
- (d)

$$\langle \omega, R(X, Y)Z \rangle = -\langle R(X, Y)\omega, Z \rangle . \quad (2.13)$$

Proof. (a) $R(X, Y)f = X(Yf) - Y(Xf) - [X, Y]f = 0$; (b) follows from the product rule for ∇_X (property (d)); (c) from (c) for ∇_X ; (d) From (a-c) we have

$$\begin{aligned} 0 &= R(X, Y)\langle \omega, Z \rangle = R(X, Y) \text{tr}(Z \otimes \omega) = \text{tr } R(X, Y)(Z \otimes \omega) \\ &= \text{tr}(R(X, Y)Z \otimes \omega) + \text{tr}(Z \otimes R(X, Y)\omega) = \langle \omega, R(X, Y)Z \rangle + \langle R(X, Y)\omega, Z \rangle . \end{aligned}$$

\square

Components (w.r.t. a coordinate basis $e_i = \partial/\partial x^i$, $e^i = dx^i$). From $[e_i, e_j] = 0$ we have

$$T^k{}_{ij} = \langle e^k, \nabla_{e_i} e_j - \nabla_{e_j} e_i \rangle = \Gamma^k{}_{ij} - \Gamma^k{}_{ji} . \quad (2.14)$$

In particular we have

$$\begin{aligned} T = 0 &\iff \Gamma^k{}_{ij} = \Gamma^k{}_{ji} , \\ R^i{}_{jkl} &= \langle e^i, (\nabla_{e_k} \nabla_{e_l} - \nabla_{e_l} \nabla_{e_k}) e_j \rangle = \langle e^i, \nabla_{e_k} (\Gamma^s{}_{lj} e_s) - \nabla_{e_l} (\Gamma^s{}_{kj} e_s) \rangle \\ &= \Gamma^i{}_{lj,k} - \Gamma^i{}_{kj,l} + \Gamma^s{}_{lj} \Gamma^i{}_{ks} - \Gamma^s{}_{kj} \Gamma^i{}_{ls} . \end{aligned} \quad (2.15)$$

Bianchi identities for the special case of *vanishing torsion*, $T = 0$:

$$\begin{aligned} 1) &\quad R(X, Y)Z + \text{cycl.} = 0 , \\ 2) &\quad (\nabla_X R)(Y, Z) + \text{cycl.} = 0 . \end{aligned} \quad (2.16)$$

Proof. 1) Let us write $X_1 = X$, $X_2 = Y$, $X_3 = Z$ and suppress the sum over $i = 1, 2, 3$ from the notation:

$$\begin{aligned}
R(X_i, X_{i+1})X_{i+2} &= \underbrace{\nabla_{X_i} \nabla_{X_{i+1}} X_{i+2}} - \underbrace{\nabla_{X_{i+1}} \nabla_{X_i} X_{i+2}} - \nabla_{[X_i, X_{i+1}]} X_{i+2} \\
\text{cyclic permutation} &\quad \underbrace{\nabla_{X_{i+2}} \nabla_{X_i} X_{i+1}} \quad \underbrace{\nabla_{X_{i+2}} \nabla_{X_{i+1}} X_i} \\
T = 0 : &\quad \nabla_{X_{i+2}} [X_i, X_{i+1}]
\end{aligned}$$

hence, $R(X_i, X_{i+1})X_{i+2} = [X_{i+2}, [X_i, X_{i+1}]] = 0$ because of (1.11).

2)

$$(\nabla_{X_i} R)(X_{i+1}, X_{i+2}) = \begin{array}{l} \nabla_{X_i} R(X_{i+1}, X_{i+2}) - R(X_{i+1}, X_{i+2}) \nabla_{X_i} \\ -R(\nabla_{X_i} X_{i+1}, X_{i+2}) - R(X_{i+1}, \nabla_{X_i} X_{i+2}), \end{array} \quad \left| \begin{array}{l} I \\ II \end{array} \right.$$

where, through cyclic permutation,

$$\begin{aligned}
I &= \underbrace{\nabla_{X_i} \nabla_{X_{i+1}} \nabla_{X_{i+2}}}_{=0} - \underbrace{\nabla_{X_i} \nabla_{X_{i+2}} \nabla_{X_{i+1}}}_{=0} - \nabla_{X_i} \nabla_{[X_{i+1}, X_{i+2}]} \\
&\quad - \underbrace{\nabla_{X_{i+1}} \nabla_{X_{i+2}} \nabla_{X_i}}_{=0} + \underbrace{\nabla_{X_{i+2}} \nabla_{X_{i+1}} \nabla_{X_i}}_{=0} + \nabla_{[X_{i+1}, X_{i+2}]} \nabla_{X_i} \\
&= R([X_{i+1}, X_{i+2}], X_i) + \underbrace{\nabla_{[[X_{i+1}, X_{i+2}], X_i]}}_{=0}, \\
II &= -R(\nabla_{X_{i+1}} X_{i+2}, X_i) + R(\nabla_{X_i} X_{i+2}, X_{i+1}) \\
&= -R(\nabla_{X_{i+1}} X_{i+2}, X_i) + R(\nabla_{X_{i+2}} X_{i+1}, X_i) = -R([X_{i+1}, X_{i+2}], X_i).
\end{aligned}$$

□

In component notation:

$$\begin{aligned}
1) &\quad R^i{}_{jkl} + \text{cycl. } (jkl) = 0, \\
2) &\quad R^i{}_{jkl;m} + \text{cycl. } (klm) = 0.
\end{aligned}$$

On the meaning of curvature

Let X, Y be vector fields with corresponding flows φ_t, ψ_s satisfying $[X, Y] = 0$. Then $R(X, Y) = \nabla_X \nabla_Y - \nabla_Y \nabla_X$ and $\varphi_t \circ \psi_s = \psi_s \circ \varphi_t$, see (1.17). Let $\tau_X(t) : T_p \rightarrow T_{\varphi_t(p)}$ be the parallel transport along the orbit $\varphi_{t'}(p)$, ($0 \leq t' \leq t$), of X , and similarly for $\tau_Y(s)$. By (2.7) we have $(d/dt)\tau_X(t)Z|_{t=0} = -\nabla_X Z$ for a vector field Z . We transport Z along a small loop consisting of orbits and obtain

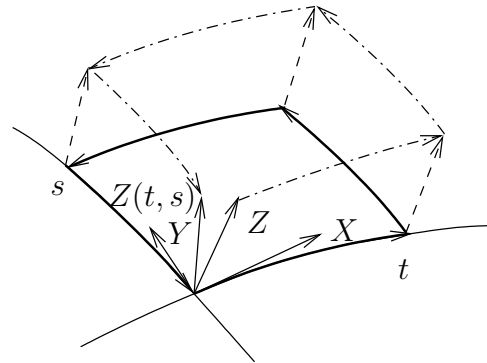

$$Z(t, s) := \tau_Y(-s)\tau_X(-t)\tau_Y(s)\tau_X(t)Z.$$

Since $Z(t, s) = Z$ for $t = 0$ or $s = 0$, the lowest order term of the Taylor expansion $Z(t, s) - Z$ is proportional to ts . With

$$\begin{aligned}\frac{\partial}{\partial t}Z(t, s)\Big|_{t=0} &= \tau_Y(-s)\nabla_X\tau_Y(s)Z - \nabla_XZ , \\ \frac{\partial^2}{\partial s\partial t}Z(t, s)\Big|_{t=s=0} &= (\nabla_Y\nabla_X - \nabla_X\nabla_Y)Z = -R(X, Y)Z .\end{aligned}$$

we find

$$Z(t, s) = Z - tsR(X, Y)Z + O(|(t, s)|^3) :$$

The curvature measures the deviation of a vector, before and after the transport around the loop.

On the meaning of torsion

The parallel transport τ allows to relate a path $\gamma(t)$ in the manifold M , going through $\gamma(0) = p$, with a path $\Gamma(t)$ in the tangent space T_p , going through $\Gamma(0) = 0$; in fact by means of

$$\dot{\Gamma}(t) = \tau(0, t)\dot{\gamma}(t) \tag{2.17}$$

by noticing: Since T_p is a linear space (unlike M), the derivative $\dot{\Gamma}(t)$ is well-defined in T_p . On the r.h.s. $\dot{\gamma}(t) \in T_{\gamma(t)}$ is transported by $\tau(0, t)$ back to T_p along the curve already traced, i.e. $\gamma(t')$, ($0 \leq t' \leq t$).

For a closed path γ its counterpart Γ does *not* need to be closed. We discuss this based on the figure used in the previous item. Let X, Y be as there, whence $T(X, Y) = \nabla_X Y - \nabla_Y X$. The (closed) path γ is determined by t, s and let $\Gamma(t, s) \in T_p$ be the endpoint of Γ . Eq. (2.17) is to be integrated along the four sides of the path. We group the contributions from the two sides in direction of X , resp. Y :

$$\begin{aligned}\Gamma(t, s) &= \Gamma_X(t, s) + \Gamma_Y(t, s) , \\ \Gamma_X(t, s) &= \int_0^t \dot{\Gamma}_X(t, s; t') dt' , \\ \dot{\Gamma}_X(t, s; t') &= \tau_X(0, t')X_+(t') - \tau_X(0, t)\tau_Y(0, s)\tau_X(t, t')X_-(t')\end{aligned}$$

with $X_+(t') = X_{\varphi_{t'}(p)}$ and $X_-(t') = X_{\varphi_{t'-t} \circ \psi_s \circ \varphi_t(p)}$ being the vector field X along the near resp. far side w.r.t. p or, equivalently, along the sides oriented positively resp. negatively w.r.t. X . (The term Γ_Y is likewise defined.) Like $Z(t, s) - Z$ in the discussion of curvature, the Taylor expansion of $\Gamma(t, s)$ begins with ts . We have

$$\begin{aligned}\frac{\partial}{\partial t}\Gamma_X(t, s)\Big|_{t=0} &= \dot{\Gamma}_X(0, s; 0) = X_p - \tau_Y(0, s)X_{\psi_s(p)} , \\ \frac{\partial^2}{\partial s\partial t}\Gamma_X(t, s)\Big|_{t=s=0} &= -\frac{\partial}{\partial s}\tau_Y(0, s)X_{\psi_s(p)} = -\nabla_Y X ;\end{aligned}$$

and likewise $(\partial^2/\partial t\partial s)\Gamma_Y(t, s)|_{t=s=0} = \nabla_X Y$ with the opposite sign because the near side is negatively oriented here. Thus,

$$\Gamma(t, s) = tsT(X, Y) + O(|(t, s)|^3) :$$

The torsion measures the failure of the tangent vectors of a loop to add up to zero.

2.3. The Cartan structure equations

Let $(e_1, \dots, e_n), (e^1, \dots, e^n)$ be any pair of dual bases of (local) vector fields, resp. 1-forms, i.e. not necessarily coordinate bases. For a given connection ∇ we define the **connection forms** ω^i_k by

$$\omega^i_k(X) = \langle e^i, \nabla_X e_k \rangle, \quad (2.18)$$

resp. $\nabla_X e_k = \omega^i_k(X)e_i$. The ω^i_k are 1-forms because of (2.10). Conversely, any set of 1-forms ω^i_k defines a connection through

$$\nabla_X Y = \nabla_X(Y^k e_k) = \underbrace{[XY^i + Y^k \omega^i_k(X)]}_{(\nabla_X Y)^i} e_i. \quad (2.19)$$

From $\nabla_X \langle e^i, e_k \rangle = \nabla_X \delta^i_k = 0$ we have

$$\langle \nabla_X e^i, e_k \rangle = -\omega^i_k(X).$$

These equations allow to express the components w.r.t that basis of the covariant derivative of any tensor field, e.g. of a 1-form Ω

$$(\nabla_X \Omega)_i = X\Omega_i - \omega^k_i(X)\Omega_k.$$

Remarks. 1) As the pair of bases changes, $\bar{e}_i = \phi_i^k e_k$, $\bar{e}^i = \phi^i_k e^k$, so do the connection forms

$$\bar{\omega}^i_k = \phi^i_l \phi_k^r \omega^l_r + \phi^i_l d\phi_k^l.$$

2) In a coordinate basis we have (cf. (2.12))

$$\omega^i_k(e_l) = \Gamma^i_{lk}, \quad (2.20)$$

hence

$$\omega^i_k(X) = \Gamma^i_{lk} X^l, \quad \text{i.e.} \quad \omega^i_k = \Gamma^i_{lk} dx^l.$$

Definition

$$\begin{aligned} T^i(X, Y) &= \langle e^i, T(X, Y) \rangle, & \text{(Torsion forms)}, \\ \Omega^i_k(X, Y) &= \langle e^i, R(X, Y)e_k \rangle, & \text{(Curvature forms)}. \end{aligned}$$

These 2-forms are determined by the connection forms:

Cartan structure equation

$$\begin{aligned} T^i &= de^i + \omega^i_k \wedge e^k, \\ \Omega^i_k &= d\omega^i_k + \omega^i_l \wedge \omega^l_k. \end{aligned} \quad (2.21)$$

Proof. From (1.28) we have

$$de^i(X, Y) = Xe^i(Y) - Ye^i(X) - e^i([X, Y]),$$

whereas (2.19), i.e.,

$$e^i(\nabla_X Y) = Xe^i(Y) + (\omega^i_k \otimes e^k)(X, Y),$$

implies

$$T^i(X, Y) = (\omega^i_k \wedge e^k)(X, Y) + \underbrace{Xe^i(Y) - Ye^i(X) - e^i([X, Y])}_{de^i(X, Y)}$$

since $\omega_1 \wedge \omega_2 = \omega_1 \otimes \omega_2 - \omega_2 \otimes \omega_1$ for 1-forms, cf. (1.22). The 2nd structure equations follows similarly from (2.18), i.e.,

$$\nabla_Y e_k = \omega^l_k(Y) e_l ,$$

and from (2.19), giving

$$e^i(\nabla_X \nabla_Y e_k) = X\omega^i_k(Y) + \omega^i_l(X)\omega^l_k(Y)$$

and hence

$$\begin{aligned} \Omega^i_k(X, Y) &= e^i((\nabla_X \nabla_Y - \nabla_Y \nabla_X - \nabla_{[X, Y]})e_k) \\ &= (\omega^i_l \wedge \omega^l_k)(X, Y) + \underbrace{X\omega^i_k(Y) - Y\omega^i_k(X) - \omega^i_k([X, Y])}_{d\omega^i_k(X, Y)} . \end{aligned}$$

□

Components

$$T^i_{jk} = T^i(e_j, e_k) ; \quad R^i_{jkl} = \Omega^i_j(e_k, e_l) , \quad (2.22)$$

resp.

$$T^i = \frac{1}{2} T^i_{jk} e^j \wedge e^k ; \quad \Omega^i_j = \frac{1}{2} R^i_{jkl} e^k \wedge e^l .$$

Remark: In a coordinate basis (i.e., $e^i = dx^i$, $de^i = 0$, eqs. (2.22, 2.21, 2.20) allow to recover (2.14, 2.15).

Finally we write once more the **Bianchi identities**, again for the case of vanishing torsion $T = 0$, but this time in the Cartan formalism

$$\begin{aligned} 1) \quad & \Omega^i_k \wedge e^k = 0 , \\ 2) \quad & d\Omega^i_k = \Omega^i_l \wedge \omega^l_k - \omega^i_l \wedge \Omega^l_k . \end{aligned}$$

Proof. 1) The exterior derivative of the first eq. (2.21) yields, because of $T^i = 0$,

$$\begin{aligned} 0 = d(\omega^i_k \wedge e^k) &= \underbrace{d\omega^i_k}_{(2.21): \Omega^i_k - \omega^i_l \wedge \omega^l_k} \wedge e^k - \omega^i_k \wedge \underbrace{de^k}_{-\omega^k_l \wedge e^l} \\ &= \Omega^i_k \wedge e^k - \omega^i_l \wedge \omega^l_k \wedge e^k + \omega^i_k \wedge \omega^k_l \wedge e^l = 0 . \end{aligned}$$

hence

$$\Omega^i_k \wedge e^k = \omega^i_l \wedge \omega^l_k \wedge e^k - \omega^i_k \wedge \omega^k_l \wedge e^l = 0 .$$

2) The exterior derivative of the second eq. (2.21) yields

$$\begin{aligned} d\Omega^i_k &= \underbrace{d\omega^i_l}_{\Omega^i_l - \omega^i_j \wedge \omega^j_l} \wedge \omega^l_k - \omega^i_l \wedge \underbrace{d\omega^l_k}_{\Omega^l_k - \omega^l_j \wedge \omega^j_k} \\ &= \Omega^i_l \wedge \omega^l_k - \omega^i_l \wedge \Omega^l_k - \omega^i_j \wedge \omega^j_l \wedge \omega^l_k + \omega^i_l \wedge \omega^l_j \wedge \omega^j_k \end{aligned}$$

□

One checks, e.g. by using a coordinate basis, that the above form of the Bianchi identities agrees with the one seen previously.

3. Pseudo-Riemannian manifolds

3.1. Metric

Let M be equipped with a **pseudo-Riemannian metric**: a symmetric, non-degenerate tensor field

$$g(X, Y) \equiv (X, Y)$$

of type $\binom{0}{2}$. Non-degenerate means that for any $p \in M$ and $(X, Y \in T_p)$ one has

$$g_p(X, Y) = 0, \quad \forall Y \in T_p \Rightarrow X = 0. \quad (3.1)$$

In particular, a vector $X \in T_p$ is determined by the values $g_p(X, Y)$, ($Y \in T_p$).

In components:

$$(X, Y) = g_{ik} X^i Y^k$$

with $g_{ik} = g_{ki}$ and $\det(g_{ik}) \neq 0$.

In passing we remark that the metric is called Riemannian, if (3.1) is replaced by the stronger condition, known as positivity ($X \in T_p$):

$$g_p(X, X) \geq 0 \quad \text{and} \quad g_p(X, X) = 0 \Rightarrow X = 0.$$

It will *not* be assumed here.

The metric allows to identify vector fields with 1-forms:

$$X \mapsto gX, \quad \omega \mapsto g^{-1}\omega \quad (3.2)$$

by means of

$$\langle gX, Y \rangle = (X, Y), \quad \langle g^{-1}\omega, Y \rangle = \langle \omega, Y \rangle.$$

The maps (3.2) are called **lowering**, resp. **raising indices**, because for $\tilde{X} = gX$, $\tilde{\omega} = g^{-1}\omega$ we have

$$\tilde{X}_i = g_{ik} X^k, \quad \tilde{\omega}^i = g^{ik} \omega_k,$$

where (g^{ik}) denotes the inverse of the matrix (g_{ik}) . We henceforth suppress the \sim and speak of X^i and X_i as of the contravariant, resp. covariant components of the same vector X . By the same token we can identify different types of tensor fields having the same number of indices. In components (e.g.):

$$T^i_k = T_{lk} g^{il} = T^{il} g_{lk}.$$

(Note the consistency of g^{ik} as obtained from g_{ik} by inversion resp. by raising both indices.) Finally, given a basis (e_1, \dots, e_n) of T_p , the covectors of the dual basis (e^1, \dots, e^n) become themselves vectors in T_p ; actually, we have

$$e_i = g_{ij} e^j,$$

as seen by comparing $(e_i, X) = g_{ij} X^j$ with $(e^j, X) = \langle e^j, X \rangle = X^j$. It is *not* possible to pick a self-dual basis, $e_i = e^i$, not even at a point. In fact that would imply $g_{ij} = \delta_{ij}$ and hence positivity of the metric. See however Sect. 3.3.

3.2. The Levi-Civita connection

The metric distinguishes an affine connection, called **Levi-Civita** (or **Riemann**) connection.

Theorem: There is a unique connection with vanishing torsion, $T = 0$, and

$$\nabla g = 0 . \quad (3.3)$$

It is given by

$$2(\nabla_X Y, Z) = X(Y, Z) + Y(Z, X) - Z(X, Y) - ([Y, Z], X) + ([Z, X], Y) + ([X, Y], Z) . \quad (3.4)$$

Proof: uniqueness: because of (3.3) we have

$$\begin{aligned} 0 &= \nabla g(X_i, X_{i+1}, X_{i+2}) = (\nabla_{X_{i+2}} g)(X_i, X_{i+1}) \\ &= X_{i+2}g(X_i, X_{i+1}) - g(\nabla_{X_{i+2}} X_i, X_{i+1}) - \underbrace{g(X_i, \nabla_{X_{i+2}} X_{i+1})}_{g(\nabla_{X_{i+2}} X_{i+1}, X_i)} \end{aligned} \quad (3.5)$$

By taking the combination $(3.5)_{i+1} + (3.5)_{i+2} - (3.5)_i$, we obtain

$$\begin{aligned} 0 &= X_i g(X_{i+1}, X_{i+2}) + X_{i+1} g(X_{i+2}, X_i) - X_{i+2} g(X_i, X_{i+1}) \\ &\quad - \underbrace{g(\nabla_{X_{i+1}} X_{i+2} - \nabla_{X_{i+2}} X_{i+1}, X_i)}_{[X_{i+1}, X_{i+2}]} + \underbrace{g(\nabla_{X_{i+2}} X_i - \nabla_{X_i} X_{i+2}, X_{i+1})}_{[X_{i+2}, X_i]} \\ &\quad - \underbrace{g(\nabla_{X_i} X_{i+1} + \nabla_{X_{i+1}} X_i, X_{i+2})}_{2\nabla_{X_i} X_{i+1} - [X_i, X_{i+1}]} , \end{aligned} \quad (3.6)$$

(underbracing uses torsion = 0), which for $i = 1$, $X_1 = X$, $X_2 = Y$, $X_3 = Z$ agrees with (3.4). That determines $\nabla_X Y$ since g is non-degenerate.

Existence: First, a vector field $\nabla_X Y$ is defined by (3.4) after checking that its r.h.s. is \mathcal{F} -linear in Z . Second, one verifies that $\nabla_X Y$ enjoys the properties of a connection, e.g. the \mathcal{F} -linearity in X :

$$\begin{aligned} 2(\nabla_{fX} Y, Z) &= fX(Y, Z) + \underbrace{Y(fX, Z)}_{fY(X, Z) + (Yf)(X, Z)} - \underbrace{Z(fX, Y)}_{fZ(X, Y) + (Zf)(X, Y)} \\ &\quad - ([Y, Z], fX) + \underbrace{([Z, fX], Y)}_{f[Z, X] + (Zf)X} + \underbrace{([fX, Y], Z)}_{f[X, Y] - (Yf)X} \\ &= 2f(\nabla_X Y, Z) , \end{aligned}$$

i.e. $\nabla_{fX} Y = f\nabla_X Y$. The vanishing of the torsion is manifest from

$$2(\nabla_X Y - \nabla_Y X, Z) = 2([X, Y], Z) .$$

Finally (3.4), or its equivalent form (3.6), implies $(3.6)_{i+1} + (3.6)_{i+2} \equiv 2 \times (3.5)_i$, which is in turn equivalent to (3.3). \square

In a chart the Lev-Civita connection reads

$$\Gamma^i{}_{lk} = \frac{1}{2}g^{ij}(g_{lj,k} + g_{kj,l} - g_{lk,j}) , \quad (3.7)$$

since for $X = \partial/\partial x^l$, $Y = \partial/\partial x^k$, $Z = \partial/\partial x^j = g_{ij}dx^i$ (3.4) reads, cf. (2.12)

$$2g_{ij}\Gamma^i{}_{lk} = g_{kj,l} + g_{jl,k} - g_{lk,j} .$$

Geodesics:

A parameterized curve $x(\lambda)$, ($\lambda_1 \leq \lambda \leq \lambda_2$) is a **geodesic** if it solves the variational principle

$$\delta \int_{(1)}^{(2)} d\lambda (\dot{x}, \dot{x}) = 0$$

with fixed endpoints $(\lambda_i, x(\lambda_i))$, ($i = 1, 2$). Here $\dot{x} = dx/d\lambda$ denotes the tangent vector. In any chart the geodesics satisfy the Euler-Lagrange equations corresponding to the Lagrangian

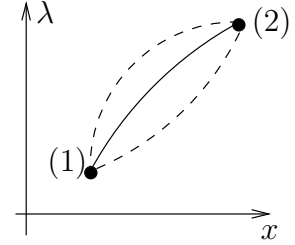

$$L(x, \dot{x}) = \frac{1}{2}g_{lk}(x)\dot{x}^l\dot{x}^k , \quad (3.8)$$

namely:

$$\begin{aligned} 0 &= \frac{d}{d\lambda} \frac{\partial L}{\partial \dot{x}^j} - \frac{\partial L}{\partial x^j} = \frac{d}{d\lambda} (g_{lj}\dot{x}^l) - \frac{1}{2}g_{lk,j}\dot{x}^l\dot{x}^k \\ &= \underbrace{g_{lj,k}\dot{x}^l\dot{x}^k}_{(1/2)(g_{lj,k} + g_{kj,l})} + g_{ij}\ddot{x}^i - \frac{1}{2}g_{lk,j}\dot{x}^l\dot{x}^k \end{aligned}$$

i.e.

$$g_{ij}\ddot{x}^i + \frac{1}{2}(g_{lj,k} + g_{kj,l} - g_{lk,j})\dot{x}^l\dot{x}^k = 0 ,$$

or

$$\ddot{x}^i + \Gamma^i{}_{lk}\dot{x}^l\dot{x}^k = 0 \quad (3.9)$$

(**geodesic equation**). It states that the vector \dot{x} is parallel transported along the geodesic, cf. (2.3).

Moreover, (3.9) is invariant under reparameterization $\lambda \mapsto \lambda'$ only if $d^2\lambda'/d\lambda^2 = 0$. The parameterization is thus fixed by (3.9) up to $\lambda \mapsto a\lambda + b$ (with a, b constants): λ is then called an **affine parameter**.

Properties of the Levi Civita connection

(a) The inner product of any two vectors remains constant upon parallel transporting them along any curve γ :

$$(X(t), Y(t))_{\gamma(t)} = (X, Y)_{\gamma(0)} \quad (3.10)$$

with $X(t) = \tau(t, 0)X$, $Y(t) = \tau(t, 0)Y$ and $X, Y \in T_{\gamma(0)}$. Indeed, because of $\nabla g = 0$ we have $g_{\gamma(t)} = \tau(t, 0)g_{\gamma(0)}$, so that (3.10) is equivalent to

$$(\tau(t, 0)g_{\gamma(0)})(\tau(t, 0)X, \tau(t, 0)Y) = g_{\gamma(0)}(X, Y) ,$$

which holds true by (2.6).

(b) The covariant derivative commutes with raising and lowering indices, e.g.

$$T^i{}_{k;l} = (g_{km}T^{im})_{;l} = g_{km}T^{im}{}_{;l}$$

because $g_{km;l} = 0$. The same without reference to coordinates:

$$\nabla_X \circ g = g \circ \nabla_X , \tag{3.11}$$

where g denotes the map (3.2). **Proof:** By (2.8, 3.5) we have

$$\langle \nabla_X gY, Z \rangle = X \langle gY, Z \rangle - \langle gY, \nabla_X Z \rangle = \langle g \nabla_X Y, Z \rangle$$

for arbitrary vector fields Y, Z .

(c) **Riemann tensor**

The following symmetries apply:

$$(W, R(X, Y)Z) = -(Z, R(X, Y)W) , \tag{3.12}$$

$$(W, R(X, Y)Z) = (X, R(W, Z)Y) . \tag{3.13}$$

Proof: From (3.11) we have $R(X, Y)g = gR(X, Y)$ and, together with (2.13), also (3.12). Because of the 1st Bianchi identity (2.16) the l.h.s. of (3.13) equals

$$-(W, R(Y, Z)X) - (W, R(Z, X)Y)$$

as well as, in view of (3.12),

$$(Z, R(Y, W)X) + (Z, R(W, X)Y) .$$

The sum of the two expressions is symmetric in $(X, Y) \leftrightarrow (W, Z)$. □

We summarize all symmetries of the Riemann tensor:

$R^i{}_{jkl} = -R^i{}_{jlk}$		always
$\sum_{(jkl)} R^i{}_{jkl} = 0$	1. Bianchi id. }	vanishing torsion
$\sum_{(klm)} R^i{}_{jkl;m} = 0$	2. Bianchi id. }	
$R_{ijkl} = -R_{jikl}$	}	Levi-Civita connection
$R_{ijkl} = R_{klij}$		

Here $\sum_{(jkl)}$ means the sum over the cyclic permutations of j, k, l .

(d) **Ricci and Einstein tensors**

Definition:

$$R_{ik} = R^j{}_{ijk} \quad (\text{Ricci tensor}) \quad (3.14)$$

$$R = R^i{}_i \quad (\text{scalar curvature}) \quad (3.15)$$

$$G_{ik} = R_{ik} - \frac{1}{2}Rg_{ik} \quad (\text{Einstein tensor}) \quad (3.16)$$

We have:

$$\left. \begin{aligned} R_{ik} &= R_{ki} , & G_{ik} &= G_{ki} \\ R^k{}_{i;k} &= \frac{1}{2}R_{;i} \\ G^k{}_{i;k} &= 0 \end{aligned} \right\} \quad (\text{contracted 2nd Bianchi identity}) \quad (3.17)$$

Proof: $R_{ik} = g^{jl}R_{lij k} = g^{lj}R_{j k l i} = R_{ki}$.

2nd Bianchi identity:

$$R^i{}_{jkl;m} + R^i{}_{jlm;k} + R^i{}_{jmk;l} = 0 .$$

(*ik*)-trace:

$$\begin{aligned} R_{jl;m} + \underbrace{R^i{}_{jlm;i}}_{-g^{ik}R_{jklm;i}} - R_{jm;l} &= 0 , \\ R^j{}_{l;m} - g^{ik}R^j{}_{klm;i} - R^j{}_{m;l} &= 0 , \end{aligned}$$

(*jm*)-trace:

$$\underbrace{R^j{}_{l;j} + g^{ik}R_{kl;i}}_{2R^j{}_{l;j}} - R_{;l} = 0 .$$

□

3.3. Supplementary material

Normal coordinates

The signature of the metric g_p is the same for all $p \in M$ (if M is connected). Let

$$\eta_{ij} = \begin{cases} 0 , & (i \neq j) \\ \pm 1 , & (i = j) \end{cases}$$

be its normal form.

Theorem: In some neighborhood of any point $p \in M$ there is a chart such that $x^i = 0$ at p and

$$\begin{aligned} g_{ij}(0) &= \eta_{ij} , \\ g_{ij,l}(0) &= 0 , \quad \text{i.e.} \quad \Gamma^i{}_{lj}(0) = 0 . \end{aligned} \quad (3.18)$$

Proof: We first pick local coordinates x^i near p such that $x^i = 0$ at p and $g_{ij}(0) = \eta_{ij}$, where the latter condition can be achieved by means of a linear transformation. Then we construct the **exponential map** from $T_p(M)$ to M :

Let $e \in T_p$. The curve $t \mapsto x(t)$ is the solution of the geodesic equation (3.9) with $\dot{x}(0) = e$. The map $\exp : y = te \mapsto x(t)$ is uniquely defined, i.e. independent of the factorization $y = te$. Thereby a neighborhood of the origin in $T_p(M)$ is mapped differentiably to M . By the geodesic equation we then have

$$\begin{aligned} x^i(t) &= t\dot{x}^i(0) + \frac{1}{2}t^2\ddot{x}^i(0) + O(t^3) \\ &= y^i - \frac{1}{2}\Gamma^i_{lk}(0)y^ly^k + O(y^3), \end{aligned}$$

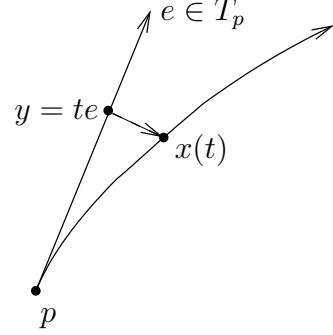

and in particular $\partial x^i / \partial y^j = \delta^i_j$ at $y = 0$. Hence \exp is a local diffeomorphism and we can take the y^i as new local coordinates. Since the geodesics through $y = 0$ then become straight lines, we have in the new coordinates

$$\Gamma^i_{lk}(te)e^le^k = 0$$

for all $e \in T_p$. Because of the symmetry $\Gamma^i_{lk} = \Gamma^i_{kl}$ we have

$$\Gamma^i_{lk}(0) = 0.$$

This is equivalent to $g_{ij,l}(0) = 0$, since then $0 = g_{ij;l} = g_{ij,l}$, while the converse is evident from (3.7).

The volume element

The metric, first defined on vector fields and 1-forms, generalizes to tensor fields of type $\binom{0}{p}$ by means of

$$(\omega_1 \otimes \dots \otimes \omega_p, w_1 \otimes \dots \otimes w_p)_p := \frac{1}{p!} \prod_{i=1}^p (\omega_i, w_i)$$

and bilinearity. It remains non-degenerate. In particular, it is defined on n -forms (with signature $\sigma = \pm 1$). On an orientable manifold there is an n -form η , unique up to the sign, with

$$(\eta, \eta)_n = \sigma. \tag{3.19}$$

η is called the volume form of the metric g . W.r.t. a basis of 1-forms we have

$$\eta = \pm |g|^{1/2} e^1 \wedge \dots \wedge e^n,$$

where

$$g = \det(g_{ij}), \quad g_{ij} = g(e_i, e_j).$$

Indeed,

$$\begin{aligned} (\eta, \eta)_n &= |g| (e^1 \wedge \dots \wedge e^n, e^1 \wedge \dots \wedge e^n)_n = |g| \sum_{\pi \in S_n} \text{sgn } \pi \prod_{i=1}^n (e^i, e^{\pi(i)}) \\ &= |g| \underbrace{\det(g^{ij})}_{g^{-1}} = \text{sgn } g = \sigma. \end{aligned}$$

In components

$$\eta_{i_1 \dots i_n} = \pm |g|^{1/2} \varepsilon_{i_1 \dots i_n} ,$$

where

$$\varepsilon_{i_1 \dots i_n} = \text{sgn} \begin{pmatrix} 1 \dots n \\ i_1 \dots i_n \end{pmatrix} .$$

The structure equations of the Levi-Civita connection

Theorem: In any basis (not necessarily a coordinate basis) the connection coefficients ω^i_k , cf. (2.18), are uniquely determined by

$$\omega_{ik} + \omega_{ki} = dg_{ik} , \quad (\nabla g = 0) \quad (3.20)$$

$$de^i + \omega^i_k \wedge e^k = 0 , \quad (\text{torsion zero}) \quad (3.21)$$

where we set

$$\omega_{ik} = g_{il} \omega^l_k .$$

Proof: For all X, e_i, e_k one has

$$\begin{aligned} 0 &= (\nabla_X g)(e_i, e_k) = X \underbrace{g(e_i, e_k)}_{g_{ik}} - g(\underbrace{\nabla_X e_i}_{\omega^l_i(X) e_l}, e_k) - g(e_i, \underbrace{\nabla_X e_k}_{\omega^l_k(X) e_l}) \\ &= dg_{ik}(X) - \omega^l_i(X) g_{lk} - \omega^l_k(X) g_{il} . \end{aligned}$$

Thus (3.20) is equivalent to $\nabla g = 0$. According to (2.21), eq. (3.21) means $T = 0$. Conversely, these two equations determine, by the theorem on p. 26 the connection (and hence the connection forms) uniquely. \square

4. Time, space and gravitation

4.1. The classical relativity principle

Clocks and global, rigid frames are at the basis of the classical idea of time and space: Simultaneity is absolute and space is Euclidean. Newtonian Mechanics distinguishes a special class of trajectories: those of **free particles**, which may be identified with particles far away from any others. The 1st Law postulates the existence of special rigid frames, so-called **inertial frames** (IF), in which *all* such trajectories take the simple form

$$\ddot{\vec{x}} = 0.$$

(Note that in this setup geometry is prior to physics.) The **classical relativity principle** (or equivalence principle) postulates that the equations of motion of any isolated system read the same in all IF. The 2nd Law specifies the deviation from a free trajectory

$$m_i \ddot{\vec{x}}_i = \vec{F}_i(\vec{x}_1, \dots, \vec{x}_N),$$

where the inertial mass m_i is a property of the i -th particle, and \vec{F}_i are given by force laws, such as

$$\vec{F} = e\vec{E}, \quad (e : \text{electric charge})$$

for a particle in an electric field \vec{E} , or

$$\vec{F} = \tilde{m}\vec{g}, \quad (\tilde{m} : \text{gravitational mass})$$

for a particle in a gravitational field \vec{g} . Remarkable and without explanation in the present context is the fact that

$$m = \tilde{m},$$

whence

$$\ddot{\vec{x}} = \vec{g} \tag{4.1}$$

for all freely falling particles. It ought to be noted that forces proportional to the inertial mass m do occur as fictitious forces upon using a non-inertial frame. Then

$$m\ddot{\vec{x}} = \vec{F} - 2m(\vec{\omega} \wedge \dot{\vec{x}}) - m(\dot{\vec{\omega}} \wedge \vec{x}) - m\vec{\omega} \wedge (\vec{\omega} \wedge \vec{x}) - m\vec{a}, \tag{4.2}$$

where \vec{F} is a real force as above and $\vec{\omega}$, \vec{a} are the angular velocity and the acceleration of the frame relative to an inertial one. Among the fictitious forces, $-2m(\vec{\omega} \wedge \dot{\vec{x}})$ and $-m\vec{a}$ are known as Coriolis, resp. inertial force.

4.2. The Einstein equivalence principle

Einstein interprets (4.1) in the sense that the “standard of motion” is not set by trajectories of free, but rather of freely falling particles. In this sense gravity is not a real force, but appears as an inertial force, whose proportionality to m is intrinsic. In formulae: Eq. (4.1) results from (4.2) by $\vec{F} = 0$, $\vec{\omega} = 0$, $\vec{a} = -\vec{g}$, while disregarding that \vec{a} is a constant, unlike the field $\vec{g}(\vec{x})$.

A strengthening of this point of view is the **equivalence principle** (EP, 1911).

“All freely falling, non-rotating local inertial frames (for short: LIF) are equivalent w.r.t. all local experiments therein.”

Remarks: 1) A (local) reference frame is non-rotating, if freely falling particles do not experience any velocity-dependent (Coriolis-) acceleration, locally.

2) The above formulation of the EP is heuristic, because the notion of local experiment is vague. We stress that the relative deviation of nearby freely falling particles does not constitute a local experiment.

3) The word “all” in the EP extends its scope beyond gravity itself, cf. (4.1), to other interactions, like electromagnetism. Without that strengthening one may pretend that a freely falling charge and one in absence of gravity remain distinguishable by the emission of radiation in the first case only. By the EP things are more subtle: No radiation will be observed in that case by a freely falling observer. She will instead observe it from a supported charge, since that will appear accelerated. The conclusion does however not extend to a likewise supported observer; the perhaps surprising way out is that emission itself is dependent on the observer.

A simpler application involving electromagnetism is the following.

Application: The gravitational redshift

We take the classical idea of space and time for granted and consider two reference frames: O , where we have a homogeneous gravitational field \vec{g} , and O' which is in free fall. At time $t = 0$ the two coincide and are instantaneously at rest to one another.

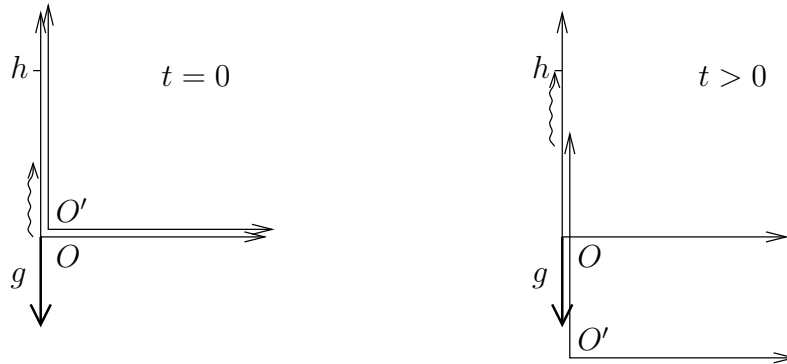

At $t = 0$ and at $\vec{x} = \vec{x}' = 0$ light of frequency ν is emitted upwards. It reaches height h w.r.t. O after time $t = h/c$. According to the EP the frequency measured in O' is still ν . But since O' has then acquired the velocity $v = -gt$ relatively to O , the latter finds the Doppler shifted frequency

$$\bar{\nu} = \nu \left(1 + \frac{v}{c} \right) = \nu \left(1 - \frac{gh}{c^2} \right). \quad (4.3)$$

Upon raising in the gravitational field the frequency decreases (or: it is shifted towards the red).

4.3. The postulates of general relativity (GR)

The postulates (Einstein 1915) clarify and extend the EP:

1. Time and space form a 4-dimensional pseudo-Riemannian manifold M : Its points p represent events and the metric g of signature $(1, -1, -1, -1)$ describes measurements by means of (ideal) clocks and rods.
2. Physical laws are relations among tensors.
3. With the exception of the metric g physical laws only contain quantities already present in special relativity (SR).
4. A local inertial frame about any event $p \in M$ is described by normal coordinates (see p. 29). In those, the laws of SR hold true.

Remarks:

About 1: • Time and space are merged into spacetime and are now devoid of separate, absolute existence. The signature reflects their dimensions. A particle, formerly thought of as a succession of events in “time”, is represented by a timelike curve, called its **world line**: an arbitrarily parameterized curve $x(\lambda) \in M$, ($\lambda \in \mathbb{R}$) with $g(\dot{x}, \dot{x}) > 0$, ($\dot{\cdot} = d/d\lambda$).

• Notation: Coordinates are generally denoted by $x = (x^\mu)$ with (Greek) indices $\mu = 0, \dots, 3$. If they are such that $(g_{00}(x))$ has signature $(+)$, i.e. $g_{00}(x) > 0$, and $(g_{ik}(x))_{i,k=1}^3$ has $(-, -, -)$ (such coordinates exist locally), then the coordinate x^0 is temporal and the (x^i) with (Latin) indices $i = 1, 2, 3$ spatial, in the sense: The curve $x^0 \mapsto (x^0, x^1, x^2, x^3)$ with fixed (x^i) is timelike.

• An ideal **clock** of world line $x = x(\lambda)$ measures (infinitesimally) the time $\Delta\tau$

$$c^2(\Delta\tau)^2 = g(\dot{x}, \dot{x})(\Delta\lambda)^2 .$$

An ideal (infinitesimal) **rod** is represented by the world line $x(\lambda)$ of one of its endpoints and by a vector $\Delta x(\lambda)$ with $g(\dot{x}, \Delta x) = 0$. Its length Δl is

$$(\Delta l)^2 = -g(\Delta x, \Delta x) .$$

In particular, if in some coordinates the world line of the clock is $x = (ct, 0, 0, 0)$, then

$$(\Delta\tau)^2 = g_{00}(x)(\Delta t)^2 . \tag{4.4}$$

One should thus distinguish between measurements by means of clocks and rods on one hand and coordinates of a chart on the other. However, local measurements done near an event p by means of clocks and rods at rest to each other define coordinates x^μ w.r.t. which the metric is **Minkowski** at p , i.e.

$$g_{\mu\nu}(x = 0) = \eta_{\mu\nu} , \tag{4.5}$$

$$\eta_{\mu\nu} = \text{diag}(+1, -1, -1, -1) . \tag{4.6}$$

Equivalently, such clocks and rods at p correspond to vectors e_0 , resp. e_i forming a basis (e_μ) of T_p with $g(e_\mu, e_\nu) = \eta_{\mu\nu}$.

In principle it is to be decided on the basis of the physical laws whether a given clock or rod is ideal. Any clock depending on gravity, like a pendulum, is not.

About 2: (Relativity principle) The physical laws read the same in all coordinates (provided the physical quantities are transformed suitably): **general covariance**.

About 4: Gravity can be transformed away locally.

Thanks to the above postulates the physical laws in presence of an external (i.e., given) gravitational field are essentially determined. The climax of GR are however the field equations of gravitation, which will be introduced in the next chapter.

4.4. Transition SR \rightarrow GR

a) Law of inertia

$$\begin{array}{ccc}
 \text{SR} & & \text{GR} \\
 \ddot{x}^\mu = 0, & \longrightarrow & (\nabla_{\dot{x}} \dot{x})^\mu \equiv \ddot{x}^\mu + \Gamma^\mu_{\nu\sigma} \dot{x}^\nu \dot{x}^\sigma = 0, \quad (4.7) \\
 (\dot{x}, \dot{x}) = c^2, & & (\dot{x}, \dot{x}) = c^2, \quad (4.8) \\
 \text{“free particle”} & & \text{“free falling particle”}
 \end{array}$$

($\dot{} = d/d\tau$, τ : proper time). The equations on the right agree with those on the left in a local inertial frame, but are generally covariant. The geodesic equation (4.7) describes the effect of the “gravitational field” on an otherwise free particle: the r.h.s. in

$$\ddot{x}^\mu = -\Gamma^\mu_{\nu\sigma} \dot{x}^\nu \dot{x}^\sigma \quad (4.9)$$

can be viewed as gravitational force, hence actually the $\Gamma^\mu_{\nu\sigma}$ (not the $g_{\mu\nu}$) as components of the gravitational field. That one can be *transformed away* by (3.18) at any point of spacetime. The “equivalence of gravitational and inertial mass” is now automatic: the mass just does not appear.

Remark: In (4.7) the $\Gamma^\mu_{\nu\sigma}$ are the Christoffel symbols of the Levi-Civita connection. Postulate 4 can be slightly weakened in the sense that the identification of a LIF with normal coordinates ($g_{\mu\nu}(0) = \eta_{\mu\nu}$, $\Gamma^\mu_{\nu\sigma}(0) = 0$) can be relaxed. Accepting eq. (4.7) for some connection ∇ , which is a priori independent of the metric, the postulate implies at first just $\Gamma^\mu_{\nu\sigma}(0) + \Gamma^\mu_{\sigma\nu}(0) = 0$ in a LIF, since the laws of SR are still presumed valid there; but then, in absence of torsion (cf. Postulate 3), also $\Gamma^\mu_{\nu\sigma}(0) = 0$, cf. (2.14). Moreover (4.8) implies that $g_{\mu\nu}(0) = \eta_{\mu\nu}$ in a LIF; and the compatibility of eqs. (4.7, 4.8) that $\nabla g = 0$. Summarizing: A LIF is nonetheless realized by normal coordinates and ∇ is the Levi-Civita connection after all.

b) For **light rays** we analogously have:

$$\begin{array}{ccc}
 \text{SR} & & \text{GR} \\
 \ddot{x}^\mu = 0, & \longrightarrow & \ddot{x}^\mu + \Gamma^\mu_{\nu\sigma} \dot{x}^\nu \dot{x}^\sigma = 0, \quad (4.10) \\
 (\dot{x}, \dot{x}) = 0, & & (\dot{x}, \dot{x}) = 0, \\
 & & \text{(null geodesics)}
 \end{array}$$

Here (4.10) describes the **light deflection** in a gravitational field. Actually the full Maxwell theory can be formulated covariantly: It suffices to replace partial derivatives (of 1st order) by covariant ones in any (fundamental) equation of SR. The recipe is known as the "comma goes to semicolon rule" ($, \rightsquigarrow ;$).

The electromagnetic field tensor F as an antisymmetric tensor field of type $\binom{0}{2}$. The homogeneous Maxwell equations then read

$$F_{\mu\nu,\sigma} + \text{cycl.} = 0 \quad \longrightarrow \quad F_{\mu\nu;\sigma} + \text{cycl.} = 0; \quad (4.11)$$

because the second form reduces to the first one in a LIF, cf. Postulate 4. The inhomogeneous equations read

$$F^{\mu\nu}{}_{;\mu} = \frac{1}{c} j^\nu \quad (4.12)$$

by the same reason. Eq. (4.12) again implies charge conservation

$$j^\nu{}_{;\nu} = 0, \quad (4.13)$$

because by $F^{\mu\nu} = -F^{\nu\mu}$ we have

$$F^{\mu\nu}{}_{;\mu\nu} = \underbrace{F^{\mu\nu}{}_{;\nu\mu}}_{-F^{\nu\mu}{}_{;\nu\mu}} + \underbrace{R^\mu{}_{\tau\mu\nu}}_{R_{\tau\nu}} F^{\tau\nu} + \underbrace{R^\nu{}_{\tau\mu\nu}}_{-R_{\tau\mu}} F^{\mu\tau} = -F^{\mu\nu}{}_{;\mu\nu}.$$

$(R_{\tau\nu} - R_{\nu\tau}) F^{\tau\nu} = 0$

The energy-momentum tensor is

$$T^{\mu\nu} = F^\mu{}_\sigma F^{\sigma\nu} - \frac{1}{4} F_{\rho\sigma} F^{\sigma\rho} g^{\mu\nu} \quad (4.14)$$

and for a "freely falling" field ($j^\nu = 0$) we have

$$T^{\mu\nu}{}_{;\nu} = 0;$$

the derivation again parallels that of $T^{\mu\nu}{}_{;\nu} = 0$ from the Maxwell equations in SR.

The representation of the electromagnetic field in terms of the potentials is

$$F_{\mu\nu} = A_{\nu,\mu} - A_{\mu,\nu} = A_{\nu;\mu} - A_{\mu;\nu}.$$

Remarks. 1) The above rule may not apply to higher derivatives, though it did in hindsight in (4.13).

2) By

$$\begin{aligned} F^{\mu\nu}{}_{;\mu} &= F^{\mu\nu}{}_{,\mu} + \Gamma^\mu{}_{\mu\sigma} F^{\sigma\nu} + \Gamma^\nu{}_{\mu\sigma} F^{\mu\sigma} \\ &= F^{\mu\nu}{}_{,\mu} + \frac{1}{2} (\Gamma^\mu{}_{\mu\sigma} + \Gamma^\mu{}_{\sigma\mu} + T^\mu{}_{\mu\sigma}) F^{\sigma\nu} + \frac{1}{2} T^\nu{}_{\mu\sigma} F^{\mu\sigma} \end{aligned}$$

it is seen that the generalization (4.12) makes use of the vanishing of the Christoffel symbols in a LIF, and thus of the torsion in general; rather than merely of their symmetric part, as in (4.7) (cf. remark on p. 35). Likewise for $A_{\nu;\mu} - A_{\mu;\nu} = A_{\nu,\mu} - A_{\mu,\nu} + T^\sigma{}_{\mu\nu} A_\sigma$.

c) The **equations of motion of a charged particle** (charge e , mass m) in an electromagnetic field and in presence of gravity now read

$$\ddot{x}^\mu + \Gamma^\mu_{\nu\sigma} \dot{x}^\nu \dot{x}^\sigma = \frac{e}{mc} F^{\mu\nu} \dot{x}_\nu, \quad (4.15)$$

because they are generally covariant (the l.h.s. is $\nabla_{\dot{x}} \dot{x}$, hence a vector) and reduce to the equations of SR in a LIF. Moreover, one verifies that (4.15) are the Euler-Lagrange equations corresponding to the manifestly covariant Hamilton principle

$$\delta \int_{(1)}^{(2)} d\tau \left(c^2 + \frac{e}{mc} (\dot{x}, A) \right) = 0$$

with fixed endpoints (1), (2) in M .

4.5. Transition geodesic equation \rightarrow Newton's equation of motion

Newton's equation of motion appears as an approximation under certain assumptions. We use coordinates which in the immediate (infinitesimal) neighborhood of the observer (not a LIF, as a rule) have the meaning of lengths and times, cf. (4.5):

$$g_{\mu\nu} = \eta_{\mu\nu} \quad \text{for } x = (ct, 0, 0, 0).$$

We follow trajectories within a region where the gravitational field is weak in the sense that

$$g_{\mu\nu} = \eta_{\mu\nu} + h_{\mu\nu}, \quad |h_{\mu\nu}| \ll 1. \quad (4.16)$$

In particular we have $h_{\mu\nu,0} = 0$ at the origin $\vec{x} = 0$. Moreover, the particle shall be slow in that frame, $v \ll c$. Then

$$\dot{x}^\mu = (c, \vec{v}), \quad (\dot{\cdot} = \frac{d}{d\tau} = \frac{d}{dt} \text{ up to } O(v^2) + O(h))$$

with $\vec{v} = d\vec{x}/dt$, as seen by inserting (4.16) in $(\dot{x}, \dot{x}) = c^2$.

At first, let the particle be nearly at rest during some (short) time, meaning that we even neglect any term $O(v)$ such as $\vec{x} \sim \vec{v}t$. Then $\dot{x}^\mu = (c, \vec{0})$ and (4.7) reads

$$\ddot{x}^i = -c^2 \Gamma^i_{00},$$

where in linear approximation in h

$$\Gamma^i_{00} = \frac{1}{2} \eta^{ik} (h_{0k,0} + h_{0k,0} - h_{00,k}) = \frac{1}{2} h_{00,i} - h_{i0,0} = \frac{1}{2} h_{00,i}, \quad (4.17)$$

cf. (4.6); in the last step we evaluated at $\vec{x} = 0$. Thus

$$\ddot{\vec{x}} = -\vec{\nabla} \varphi, \quad \varphi = \frac{1}{2} c^2 h_{00}.$$

Put differently: In a weak gravitational field we have

$$g_{00} = 1 + \frac{2\varphi}{c^2} \quad (4.18)$$

where φ is the **Newtonian potential** normalized at the observer, $\varphi(t, \vec{x} = 0) = 0$.

At a second look, we shall retain terms $\propto \vec{v}$ (i.e., we neglect only terms $O(v^2)$); then $\dot{x}^\mu = (c, \vec{v})$ and (4.7) becomes

$$\ddot{x}^i = -c^2 \Gamma^i_{00} - 2c \Gamma^i_{0j} \dot{x}^j \quad (4.19)$$

with

$$\Gamma^i_{0j} = \frac{1}{2} \eta^{ik} (h_{0k,j} + h_{jk,0} - h_{0j,k}) = \frac{1}{2} (h_{0j,i} - h_{0i,j}) .$$

Correspondingly we keep terms $O(\vec{x})$ in (4.17), since $\vec{x} \sim \vec{v}t$. For comparison, the Newtonian equation of motion of a freely falling particle in an accelerated reference frame (not an IF) is, cf. (4.2)

$$\ddot{\vec{x}} = -\vec{\nabla}\varphi - 2\vec{\omega} \wedge \dot{\vec{x}} - \vec{\omega} \wedge (\vec{\omega} \wedge \vec{x}) - \dot{\vec{\omega}} \wedge \vec{x} , \quad (4.20)$$

where the inertial acceleration is included in $\vec{\nabla}\varphi$. Now (4.19, 4.20) agree locally for

$$g_{00} = 1 + \frac{2}{c^2} (\varphi - \frac{1}{2} (\vec{\omega} \wedge \vec{x})^2) ,$$

$$g_{0i} = -\frac{1}{c} (\vec{\omega} \wedge \vec{x})_i .$$

This follows by means of $ch_{0i} = -\varepsilon_{ijk} \omega_j x_k$, $c(h_{0j,i} - h_{0i,j}) = 2\varepsilon_{jik} \omega_k$, $c\Gamma^i_{0j} \dot{x}^j = (\vec{\omega} \wedge \dot{\vec{x}})_i$, $\vec{\omega} \wedge (\vec{\omega} \wedge \vec{x}) = -(1/2) \vec{\nabla}(\vec{\omega} \wedge \vec{x})^2$ and $c^2 h_{i0,0} = -(\dot{\vec{\omega}} \wedge \vec{x})_i$.

Redshift

We consider a metric which is independent of time in suitable coordinates (ct, \vec{x}) :

$$g_{\mu\nu,0} = 0 .$$

If $(t, \vec{x}(t))$, $(t_1 \leq t \leq t_2)$, is a (null-) geodesic, then so is $(t, \vec{x}(t-t_0))$, $(t_1+t_0 \leq t \leq t_2+t_0)$. In particular, the difference Δt between consecutive minima of a light wave is constant along the ray. The proper time τ of an observer resting at \vec{x} is related to coordinate time according to (4.4)

$$(\Delta\tau)^2 = g_{00}(\vec{x})(\Delta t)^2 .$$

Hence we have for the frequency ν at the positions (1), (2) of a light ray.

$$\frac{\nu_2}{\nu_1} = \frac{(\Delta\tau)_1}{(\Delta\tau)_2} = \sqrt{\frac{g_{00}(\vec{x}_1)}{g_{00}(\vec{x}_2)}} . \quad (4.21)$$

Remarks: 1) In the situation of (4.18) (and hence with $2\varphi \ll c^2$) we have

$$\frac{\nu_2}{\nu_1} = \sqrt{1 - 2\frac{\Delta\varphi}{c^2}} \approx 1 - \frac{\Delta\varphi}{c^2}$$

with $\Delta\varphi = \varphi|_1^2$. This agrees with (4.3) ($\Delta\varphi = gh$).

2) The EP is incompatible with SR, at least if its metric $\eta_{\mu\nu}$ is supposed to describe time measurements, see (4.4): With any light ray, a time translate thereof is one too (even, if it weren't a null geodesic). With $g_{\mu\nu} = \eta_{\mu\nu}$ we would always get $\nu_2/\nu_1 = 1$ (no redshift). Gravitation can thus not be accommodated within SR.

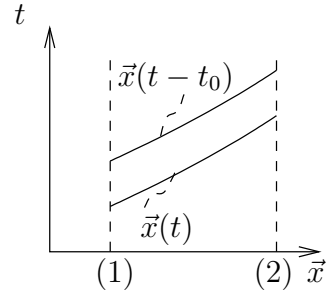

4.6. Geodesic deviation

Family of geodesics $x(\tau)$ with 4-velocity field u (cf. (4.7)):

$$\frac{dx}{d\tau} = u(x(\tau)), \quad \nabla_u u = 0, \quad g(u, u) = c^2.$$

Let φ_τ be the flow generated by u . We investigate the relative displacement of the trajectories $\varphi_\tau(p), \varphi_\tau(q)$ of two (eventually infinitesimally close) nearby points $p, q \in \gamma$ in the “surface” $\{\tau = 0\}$:

$$\begin{aligned} p, q \in \{\tau = 0\} &\mapsto \varphi_\tau(p), \varphi_\tau(q), \\ \gamma \subset \{\tau = 0\} &\mapsto \varphi_\tau \circ \gamma. \end{aligned}$$

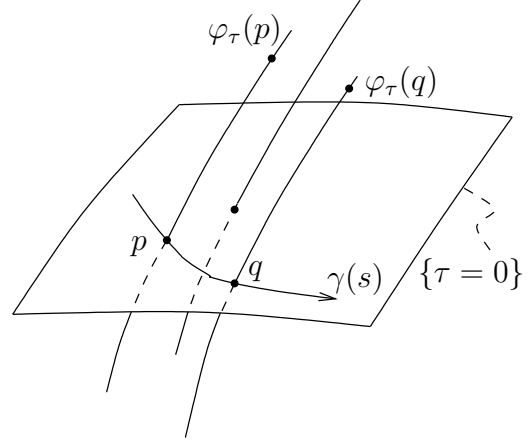

Vector fields $n = d\gamma/ds$ (“infinitesimal initial displacements”) in the surface $\{\tau = 0\}$ are mapped to $d(\varphi_\tau \circ \gamma)/ds$ as proper time τ progresses. In other words, according to

$$n_p \mapsto \varphi_{\tau*} n_p =: n_{\varphi_\tau(p)}$$

(Lie transport) and thus extended to vector fields $n = \varphi_{\tau*} n$ on M . In particular we have

$$[u, n] = \frac{d}{d\tau} \varphi_\tau^* n \Big|_{\tau=0} = 0$$

by (1.18) and property (e) thereafter. (By the way that step also follows from (1.17), since the flows of u and n commute by construction of the latter field.) This implies $\nabla_u n = \nabla_n u$ (torsion = 0) for the relative 4-velocity and

$$\nabla_u^2 n = \nabla_u \nabla_n u = (R(u, n) + \nabla_n \nabla_u) u,$$

i.e. we have the equation of **geodesic deviation**

$$\nabla_u^2 n = R(u, n) u. \quad (4.22)$$

The curvature describes the **relative acceleration** of nearby freely falling particles.

Remarks: 1) The choice of the surface $\{\tau = 0\}$ is irrelevant, since an infinitesimal change amounts to the replacement $n \rightsquigarrow n + \lambda u$ with $u\lambda = 0$; then we have $\nabla_u(\lambda u) = 0$ and $R(u, \lambda u) = 0$.

2) If the surface $\{\tau = 0\}$ is perpendicular to u , then we have

$$g(u, n) = 0$$

there, and hence everywhere, since by $\nabla g = 0$ its derivative along the above geodesics vanishes:

$$u(g(u, n)) = g(\underbrace{\nabla_u u}_{=0}, n) + g(u, \underbrace{\nabla_u n}_{=\nabla_n u}) = \frac{1}{2} n(\underbrace{g(u, u)}_{=c^2}) = 0.$$

3) Let e_μ be a basis of vector fields with $[e_\mu, u] = 0$ and $e_0 = 0$. The relative acceleration in direction i , ($i = 1, 2, 3$) of particles, whose separation is in the same direction, is $\langle e^i, \nabla_u^2 e_i \rangle$. Summed over directions we obtain

$$\sum_{i=1}^3 \langle e^i, \nabla_u^2 e_i \rangle = \langle e^\mu, \nabla_u^2 e_\mu \rangle = \langle e^\mu, R(u, e_\mu)u \rangle = -\text{Ric}(u, u) . \quad (4.23)$$

4) The geodesic deviation in Newtonian mechanics (or SR) is found by differentiating $\ddot{x}^i = -\varphi_{,i}(x)$ w.r.t. s , where $n^i = \partial x^i / \partial s|_{s=0}$. This yields

$$\ddot{n}^i = -\varphi_{,ik} n^k . \quad (4.24)$$

Incidentally: If its form in absence of gravity, $\ddot{n}^i = 0$, were to be generalized to GR by the "comma goes to semicolon rule" it would incorrectly yield $\nabla_u^2 n = 0$; cf. Remark 1 on p. 36 or 2 on p. 33.

5. The Einstein field equations

5.1. The energy-momentum tensor

The energy-momentum tensor $T^{\mu\nu}$ of a field generally describes

$$\begin{aligned} T^{00} &: \text{energy density} & T^{0i} &: c^{-1} \cdot \text{energy current density} \\ T^{i0} &: c \cdot \text{momentum density} & T^{ik} &: \text{momentum current density} . \end{aligned}$$

In SR, $T^{00}d^3x$ and $c^{-1}T^{i0}d^3x$ are the energy and the i -th component of the momentum in the volume element d^3x , respectively; moreover $c\sum_{k=1}^3 T^{0k}do_k$ and $\sum_{k=1}^3 T^{ik}do_k$ are the power and the i -th component of the force, respectively, which is exerted on an oriented area element $d\vec{\sigma} = (do_1, do_2, do_3)$. In GR the same holds true in local coordinates around an event p , where $g_{\mu\nu}(x=0) = \eta_{\mu\nu}$; or equivalently for the components $T^{\mu\nu} = T(e^\mu, e^\nu)$ in a basis (e_μ) with $g(e_\mu, e_\nu) = \eta_{\mu\nu}$, cf. (4.5).

It holds true that $T^{\mu\nu} = T^{\nu\mu}$. In SR the energy momentum conservation reads $T^{\mu\nu}{}_{;\nu} = 0$ while in GR we have by the usual rule

$$T^{\mu\nu}{}_{;\nu} = 0 . \quad (5.1)$$

Note however that this variant of the ‘‘conservation law’’ no longer allows for an integral form, as the one applying to SR did. It in fact stated that the total 4-momentum is conserved, $(d/dt) \int_{x^0=ct} T^{\mu 0} d^3x = 0$.

Example: the electromagnetic field, see (4.14). As further examples we introduce two fields as models of matter: the **dust** and the **perfect** (or ideal) **fluid**. We treat them as continua, even though they may be thought of as consisting of particles.

Dust: freely falling particles with common local velocity.

$\rho(x)$: mass density in the **local rest frame** (= energy density/ c^2 = rest mass \times particle density); a scalar by definition.

$u^\mu(x)$: 4-velocity.

In the local rest frame we have in the 1 + 3 split $x = (x^0, \vec{x})$

$$T^{\mu\nu} = \left(\begin{array}{c|c} \rho c^2 & 0 \\ \hline 0 & 0 \end{array} \right) ,$$

hence generally

$$T^{\mu\nu} = \rho u^\mu u^\nu$$

by covariance. The equations of motion of the dust are

$$(\rho u^\mu)_{;\mu} = 0 , \quad \nabla_u u = 0 . \quad (5.2)$$

The first one is the conservation of matter (particle number); the second one describes the free fall along geodesics. In view of

$$T^{\mu\nu}{}_{;\nu} = u^\mu (\rho u^\nu)_{;\nu} + \underbrace{\rho u^\nu u^\mu}_{(\nabla_u u)^\mu}{}_{;\nu} \quad (5.3)$$

we have $T^{\mu\nu}{}_{;\nu} = 0$, i.e. (5.1), from (5.2). Conversely, $T^{\mu\nu}{}_{;\nu} = 0$ and $u_\mu u^\mu = c^2$ imply (5.2). To see this, note that the projection onto u , i.e.

$$P^\sigma{}_\mu = c^{-2} u^\sigma u_\mu ,$$

leaves the first term on the r.h.s. of (5.3) unaffected, but annihilates the second one by $u_\mu(\nabla_u u)^\mu = \nabla_u(u_\mu u^\mu)/2 = 0$. So, applying that projection we get $(\rho u^\nu)_{;\nu} = 0$; while applying the complementary one yields

$$0 = \left(\delta^\sigma{}_\mu - \frac{u^\sigma u_\mu}{c^2} \right) T^{\mu\nu}{}_{;\nu} = \rho(\nabla_u u)^\sigma .$$

Perfect fluid: freely falling particles with local velocity distribution. The distribution is isotropic in its local rest frame.

$$\left. \begin{array}{ll} \varepsilon(x) & : \quad \text{energy density} \\ p(x) & : \quad \text{pressure} \end{array} \right\} \quad \text{in the local rest frame}$$

$$u^\mu(x) : \quad \text{4-velocity of the local rest frame (not of constituent particles)}$$

$$T^{\mu\nu} = \begin{pmatrix} \varepsilon & 0 & 0 & 0 \\ 0 & p & 0 & 0 \\ 0 & 0 & p & 0 \\ 0 & 0 & 0 & p \end{pmatrix} \quad (\text{in local rest frame}) \quad (5.4)$$

$$T^{\mu\nu} = (\varepsilon + p) \frac{u^\mu u^\nu}{c^2} - p g^{\mu\nu} \quad (\text{in general}) .$$

We postulate

$$T^{\mu\nu}{}_{;\nu} = 0 , \quad (5.5)$$

as the equation of motion. The number of its components matches in fact that of independent fields, provided an equation of state $p = p(\varepsilon)$ is taken into account. We note

$$T^{\mu\nu}{}_{;\nu} = \frac{u^\mu}{c^2} ((\varepsilon + p)u^\nu)_{;\nu} + \frac{\varepsilon + p}{c^2} \underbrace{u^\nu u^\mu{}_{;\nu}}_{(\nabla_u u)^\mu} - p_{;\nu} g^{\mu\nu}$$

and $P^\sigma{}_\mu g^{\mu\nu} = c^{-2} u^\sigma u^\nu$. Hence (5.5) implies by projection

$$((\varepsilon + p)u^\nu)_{;\nu} - p_{;\nu} u^\nu = 0 ,$$

i.e.

$$(\varepsilon u^\nu)_{;\nu} + p u^\nu{}_{;\nu} = 0 ; \quad (5.6)$$

resp. by complementary projection

$$\frac{\varepsilon + p}{c^2} (\nabla_u u)^\mu - \left(g^{\mu\nu} - \frac{u^\mu u^\nu}{c^2} \right) p_{;\nu} = 0 ,$$

i.e.

$$\frac{\varepsilon}{c^2} (\nabla_u u)^\mu - g^{\mu\nu} p_{;\nu} + \frac{u^\nu}{c^2} (p u^\mu)_{;\nu} = 0 . \quad (5.7)$$

Equivalently, eqs. (5.6, 5.7) are the equations of motion.

We next discuss the non-relativistic limit, $u^\mu = (c, \vec{v})$ with $|\vec{v}| \ll c$, and in fact we do so in a LIF ($\Gamma^\mu{}_{\nu\sigma} = 0$) for simplicity. Hence $\nabla_u = u^\sigma \partial_\sigma$ reduces to the material derivative $D/Dt = \partial/\partial t + \vec{v} \cdot \vec{\nabla}$ (time derivative along the velocity field \vec{v}) and (5.6, 5.7) to

$$\begin{aligned} \frac{\partial \varepsilon}{\partial t} + \operatorname{div}(\varepsilon \vec{v}) + p \operatorname{div} \vec{v} &= 0, \\ \frac{\varepsilon}{c^2} \frac{D\vec{v}}{Dt} + \vec{\nabla} p + \frac{1}{c^2} \frac{D}{Dt}(p\vec{v}) &= 0. \end{aligned} \quad (5.8)$$

This is to be compared with the Euler equations

$$\begin{aligned} \frac{\partial \rho}{\partial t} + \operatorname{div}(\rho \vec{v}) &= 0, \\ \rho \frac{D\vec{v}}{Dt} + \vec{\nabla} p &= 0 \end{aligned} \quad (5.9)$$

of Newtonian mechanics, to which (5.8) reduce only in the additional limit of a small distribution $(\Delta w)^2 \equiv \langle (\Delta \vec{w})^2 \rangle \ll c^2$ of the velocities of the constituent particles. In fact $p = \rho \cdot O((\Delta w)^2)$, $\varepsilon = \rho c^2(1 + O((\Delta w/c)^2))$, whence $p \ll \varepsilon$. The discrepancy between (5.8) and (5.9) arises because the velocity distribution can be relativistic even for $|\vec{v}| \ll c$.

Remark. In presence of several fields, possibly interacting, eq. (5.1) may fail for the individual energy-momentum tensors, but remains valid for their sum.

5.2. Field equations of gravitation

Einstein postulated in 1915 the field equations of the metric tensor $g_{\mu\nu}$

$$G^{\mu\nu} = \kappa T^{\mu\nu} \quad (5.10)$$

with κ a gravitational constant and $G^{\mu\nu}$ the tensor (3.16).

Remarks. 1. The l.h.s. reflects geometry, the r.h.s. matter: “Matter bends spacetime”.

2. By symmetry, (5.10) are 10 equations. They are non-linear partial differential equations for the metric $g = (g_{\mu\nu}(x))$ involving its derivatives of order 0, 1, 2.

3. Because of the 2nd Bianchi identity (3.17), equation (5.1) has become a consequence of (5.10) and hence a necessary condition for it having solutions (integrability condition). For dust alone, this implies even the geodesic equation $\nabla_u u = 0$!

4. Equivalent writing: taking traces yields $R - 2R = \kappa T$, hence

$$R^{\mu\nu} = \kappa \left(T^{\mu\nu} - \frac{1}{2} T g^{\mu\nu} \right) \quad (5.11)$$

and in particular

$$R^{\mu\nu} = 0 \quad (5.12)$$

in vacuum.

5. The relative acceleration between nearby geodesics with 4-velocity u is by (4.23)

$$-R_{\mu\nu}u^\mu u^\nu = -\kappa(T_{\mu\nu}u^\mu u^\nu - \frac{1}{2}Tc^2) = -\frac{\kappa c^2}{2}(\varepsilon + 3p),$$

where we used an perfect fluid (5.4) in the last step, and hence $T = \varepsilon - 3p$. Gravity is attractive for

$$\varepsilon + 3p > 0. \quad (5.13)$$

To be precise: We applied (4.23) to geodesics of test particles with velocity field \tilde{u} coinciding with the fluid velocity u on some slice $\{\tau = 0\}$ (assuming this everywhere is impossible, because $\nabla_{\tilde{u}}\tilde{u} = 0$ would conflict with (5.7), unless $p = 0$). If \tilde{u} is not linked to u , then $-R_{\mu\nu}\tilde{u}^\mu\tilde{u}^\nu \leq -\kappa c^2(\varepsilon + 3p)/2$, which exhibits gravity as even more attractive. The inequality arises by

$$\tilde{u}^\mu \frac{u_\mu u_\nu}{c^2} \tilde{u}^\nu \geq \tilde{u}^\mu g_{\mu\nu} \tilde{u}^\nu = c^2,$$

which in turn relies on $g_{\mu\nu} - c^{-2}u_\mu u_\nu \leq 0$ in the sense of quadratic forms.

6. The constant κ is (see below) essentially Newton's **gravitational constant** G_0 :

$$\kappa = \frac{8\pi G_0}{c^4}. \quad (5.14)$$

The Newtonian limiting case

$$\vec{F}_{12} = -G_0 m_1 m_2 \frac{\vec{r}}{r^3} = G_0 m_1 m_2 \vec{\nabla} \frac{1}{r}. \quad \begin{array}{c} 1 \qquad \qquad \qquad 2 \\ \bullet \text{-----} \leftarrow \bullet \\ \qquad \qquad \qquad \vec{F}_{12} \end{array}$$

For a continuous mass distribution of density ρ ($m_1 \rightsquigarrow \rho(\vec{x})d^3x$, $m_2 = m$) we get

$$\vec{F} = -m\vec{\nabla}\varphi, \quad \varphi(\vec{x}) = -G_0 \int d^3y \frac{\rho(\vec{y})}{|\vec{x} - \vec{y}|},$$

where the gravitational potential φ satisfies the Poisson equation

$$\Delta\varphi = 4\pi G_0 \rho. \quad (5.15)$$

In order to derive this limiting case from (5.10) we consider again the setting (4.16), where $\Gamma^\mu_{\nu\sigma} = O(h)$ and in particular $\Gamma^i_{00} = h_{00,i}/2$, $h_{00} = 2\varphi/c^2$. Let also the metric be time-independent. To first order in h we have

$$R^i_{0k0} = \Gamma^i_{00,k} - \underbrace{\Gamma^i_{k0,0}}_{=0} = \frac{1}{c^2}\varphi_{,ik}, \quad (5.16)$$

$$R_{00} = \frac{1}{c^2}\Delta\varphi.$$

(Alternatively, (5.16) follows by comparing (4.22, 4.24).) Moreover, let the velocities of matter be $\ll c$, both in mean ($|\vec{v}| \ll c$) and in distribution ($p \ll \varepsilon = \rho c^2$). Then $|T^{ij}| \ll T^{00}$, cf. (5.4), and hence

$$T \equiv T^\alpha_\alpha = T^0_0 = T^{00} = \rho c^2.$$

The (00)-component of the field equations (5.11) thus reads

$$\frac{1}{c^2}\Delta\varphi = \kappa\rho c^2\left(1 - \frac{1}{2}\right),$$

which coincides with (5.15) and implies (5.14).

The cosmological term

Einstein extended the field equations in 1917

$$G^{\mu\nu} - \Lambda g^{\mu\nu} = \kappa T^{\mu\nu} \tag{5.17}$$

by a term featuring the **cosmological constant** Λ . This equation is still consistent with (5.1) since $g^{\mu\nu}{}_{;\nu} = 0$. The l.h.s. (times a constant) is even the most general expression $D[g]^{\mu\nu}$, which does not contain any derivatives of g of orders higher than the second and satisfies $D[g]^{\mu\nu}{}_{;\nu} = 0$ (proof omitted).

The cosmological term can be understood in the sense of (5.10) as the energy-momentum tensor of the vacuum: $T^{\mu\nu} = (\Lambda/\kappa)g^{\mu\nu}$. It corresponds to a perfect fluid (5.4) with the unusual equation of state $\varepsilon = -p = \Lambda/\kappa$; in particular $\varepsilon + 3p = -2\Lambda/\kappa$, making gravity repulsive for $\Lambda > 0$, cf. (5.13). If the constant is small enough it remains without observable consequences at the scale of the solar system, but can eventually become dominating in an expanding universe (see next chapter), since its energy and momentum densities do not decrease, unlike those of matter.

5.3. The Hilbert action

The field equations (5.10) can be obtained from a form covariant variation principle. The action for the metric g is

$$S_D[g] = \int_D R\eta,$$

where $D \subset M$ is a compact region in space-time, R is the scalar curvature, and η is the volume element (3.19). In local coordinates,

$$S_D[g] = \int_D R\sqrt{-g}d^4x, \tag{5.18}$$

where, on the r.h.s., $g(x) = \det(g_{\mu\nu}(x))$. The Euler-Lagrange equations for (5.18) are the field equations in vacuum. More precisely:

$$\delta S_D[g] = 0$$

for any variation δg of the metric, vanishing on ∂D together with its first derivatives, is equivalent to $G_{\mu\nu} = 0$.

Without yet fixing any field at ∂D we claim

$$\delta S_D[g] = \int_D G_{\mu\nu}\delta g^{\mu\nu}\sqrt{-g}d^4x + \int_{\partial D} W^\alpha\sqrt{-g}do_\alpha, \tag{5.19}$$

where do_α is the (coordinate) normal of ∂D and

$$W^\alpha = g^{\mu\nu} \delta \Gamma^\alpha_{\mu\nu} - g^{\alpha\mu} \delta \Gamma^\nu_{\nu\mu}$$

is a vector field. Since it vanishes on ∂D the variational principle follows.

Proof of (5.19):

$$\begin{aligned} \delta \int_D R \sqrt{-g} d^4x &= \delta \int_D (R_{\mu\nu} g^{\mu\nu} \sqrt{-g}) d^4x \\ &= \int_D R_{\mu\nu} \delta(g^{\mu\nu} \sqrt{-g}) d^4x + \int_D (\delta R_{\mu\nu}) g^{\mu\nu} \sqrt{-g} d^4x . \end{aligned} \quad (5.20)$$

To compute the first term we recall that for an $n \times n$ matrix $A(\lambda)$ we have

$$\begin{aligned} \frac{d}{d\lambda} \det A &= \det A \cdot \text{tr} \left(A^{-1} \frac{dA}{d\lambda} \right) , \\ \frac{d}{d\lambda} (A^{-1}) \cdot A &= -A^{-1} \frac{dA}{d\lambda} . \end{aligned}$$

This implies

$$\begin{aligned} (\delta g^{\mu\nu}) g_{\nu\sigma} &= -g^{\mu\nu} (\delta g_{\nu\sigma}) , \\ \delta g &= g g^{\mu\nu} \delta g_{\nu\mu} , \\ \delta \sqrt{-g} &= \frac{1}{2} \sqrt{-g} g^{\mu\nu} \delta g_{\nu\mu} = -\frac{1}{2} \sqrt{-g} g_{\alpha\beta} \delta g^{\alpha\beta} , \\ \delta(g^{\mu\nu} \sqrt{-g}) &= \sqrt{-g} \delta g^{\mu\nu} - \frac{1}{2} \sqrt{-g} g^{\mu\nu} g_{\alpha\beta} \delta g^{\alpha\beta} . \end{aligned} \quad (5.21)$$

The first integrand (5.20) thus equals

$$\sqrt{-g} (R_{\mu\nu} \delta g^{\mu\nu} - \frac{1}{2} R g_{\alpha\beta} \delta g^{\alpha\beta}) = \sqrt{-g} G_{\mu\nu} \delta g^{\mu\nu}$$

and yields the first term in (5.19). As for the second, we claim the **Palatini identity**

$$\delta R_{\mu\nu} = (\delta \Gamma^\alpha_{\mu\nu})_{;\alpha} - (\delta \Gamma^\alpha_{\mu\alpha})_{;\nu} . \quad (5.22)$$

In fact, we may at fist compute the variation of

$$R_{\mu\nu} = \Gamma^\alpha_{\mu\nu,\alpha} - \Gamma^\alpha_{\mu\alpha,\nu} + \Gamma^\rho_{\mu\nu} \Gamma^\alpha_{\rho\alpha} - \Gamma^\rho_{\mu\alpha} \Gamma^\alpha_{\rho\nu}$$

at any point p in normal coordinates centered there ($p \mapsto x = 0$, $\Gamma^\alpha_{\beta\gamma}(0) = 0$), whence

$$\delta R_{\mu\nu} = (\delta \Gamma^\alpha_{\mu\nu})_{,\alpha} - (\delta \Gamma^\alpha_{\mu\alpha})_{,\nu} ,$$

which establishes (5.22) at p and in such coordinates. However $\delta \Gamma^\alpha_{\beta\gamma}$ is a tensor (though $\Gamma^\alpha_{\beta\gamma}$ is not, see exercises), as is the l.h.s. Thus (5.22) holds in any coordinates. In turn it implies by $g_{\mu\nu;\sigma} = 0$

$$g^{\mu\nu} (\delta R_{\mu\nu}) = (g^{\mu\nu} \delta \Gamma^\alpha_{\mu\nu})_{;\alpha} - (g^{\mu\nu} \delta \Gamma^\alpha_{\mu\alpha})_{;\nu} = W^\alpha_{;\alpha} . \quad (5.23)$$

Finally we have for any vector field W

$$W^\alpha{}_{;\alpha}\sqrt{-g} = (W^\alpha\sqrt{-g})_{,\alpha} , \quad (5.24)$$

whence the second term in (5.19) follows by Gauss' theorem on \mathbb{R}^4 . Eq. (5.24) follows from $W^\alpha{}_{;\alpha} = W^\alpha{}_{,\alpha} + \Gamma^\alpha{}_{\alpha\mu}W^\mu$ with

$$\Gamma^\alpha{}_{\alpha\mu} = \frac{1}{2}g^{\alpha\beta}(g_{\alpha\beta,\mu} + g_{\mu\beta,\alpha} - g_{\alpha\mu,\beta}) = \frac{1}{2}g^{\alpha\beta}g_{\alpha\beta,\mu} = \frac{\sqrt{-g}_{,\mu}}{\sqrt{-g}} ,$$

cf. (5.21). Alternatively, Gauss' theorem may be applied without reference to coordinates, cf. (1.40): $\int_D(\operatorname{div}_g W)\eta = \int_{\partial D}i_W\eta$, where $\operatorname{div}_g W = W^\alpha{}_{;\alpha}$, cf. (1.41, 5.24). \square

Remark. It follows from (5.21) that the action for $G_{\mu\nu} - \Lambda g_{\mu\nu} = 0$ is

$$S_D[g] = \int_D (R + 2\Lambda)\sqrt{-g}d^4x .$$

The action (5.18) depends, through R , on g up to its second derivatives. Usual actions however depend on the fields only up to their first derivatives; moreover, variations of the fields, but not of their derivatives, are required to vanish at the boundary. A variant of (5.18), which is of that kind, is the Palatini action

$$S_D[g, \Gamma] = \int_D g^{\alpha\beta}R_{\alpha\beta}\sqrt{-g}d^4x ,$$

where $R_{\alpha\beta}$ is the Ricci tensor of a torsion free connection Γ independent of g . Then

$$\begin{aligned} \delta_g S_D = 0 &\Leftrightarrow G_{\mu\nu} = 0 , \\ \delta_\Gamma S_D = 0 &\Leftrightarrow \nabla g = 0 ; \end{aligned}$$

thus the connection is Levi-Civita by virtue of the equations of motion.

Proof. The variations w.r.t. g and Γ yield the two terms in (5.20); hence the first one $G_{\mu\nu} = 0$ as before. As for the second, the identity (5.22) still holds true because the existence of normal coordinates ($\Gamma^\alpha{}_{\beta\gamma}(0) = 0$) just depends on $\Gamma^\alpha{}_{\beta\gamma} = \Gamma^\alpha{}_{\gamma\beta}$. However, since $g_{\mu\nu;\sigma} \neq 0$ a priori, the r.h.s. of (5.23) has to be completed by

$$-g^{\mu\nu}{}_{;\alpha}\delta\Gamma^\alpha{}_{\mu\nu} + g^{\mu\alpha}{}_{;\alpha}\delta\Gamma^\nu{}_{\mu\nu} = -(g^{\mu\nu}{}_{;\alpha} - g^{\mu\beta}{}_{;\beta}\delta_\alpha{}^\nu)\delta\Gamma^\alpha{}_{\mu\nu} ,$$

which yields the Euler-Lagrange equation

$$2g^{\mu\nu}{}_{;\alpha} - (g^{\mu\beta}{}_{;\beta}\delta_\alpha{}^\nu + g^{\nu\beta}{}_{;\beta}\delta_\alpha{}^\mu) = 0$$

by varying $\delta\Gamma^\alpha{}_{\mu\nu} = \delta\Gamma^\alpha{}_{\nu\mu}$. The $(\alpha\nu)$ -trace is $g^{\mu\alpha}{}_{;\alpha}(2 - (4 + 1)) = 0$, which inserted back gives $g^{\mu\nu}{}_{;\alpha} = 0$, as claimed. \square

The variational principle extends to matter described by any field $\psi = (\psi_A)$ transforming as a tensor (or spinor) under diffeomorphisms φ (or, equivalently, change of coordinates). Consider an action of the form

$$S_D[g, \psi] = \int_D \mathcal{L}(g, \psi, \nabla_g\psi)\eta$$

where ∇_g is the Levi-Civita connection of the metric g and the **Lagrangian** \mathcal{L} is invariant:

$$\mathcal{L}(\varphi^*g, \varphi^*\psi, \nabla_{\varphi^*g}\varphi^*\psi) = \mathcal{L}(g, \psi, \nabla_g\psi) \circ \varphi . \quad (5.25)$$

The Euler-Lagrange equations, $\delta_\psi S = 0$ (ψ fixed on ∂D), are

$$\frac{\partial \mathcal{L}}{\partial \psi_A} - \nabla^\mu \frac{\partial \mathcal{L}}{\partial (\nabla_\mu \psi_A)} = 0 . \quad (5.26)$$

A symmetric **energy-momentum tensor** $T^{\mu\nu}$ is defined through

$$\delta_g \int_D \mathcal{L}(g, \psi, \nabla_g \psi) \sqrt{-g} d^4x =: -\frac{1}{2} \int_D T^{\mu\nu}(x) \delta g_{\mu\nu}(x) \sqrt{-g(x)} d^4x .$$

Here, the l.h.s. may be read as $(d/d\lambda)S_D[g + \lambda\delta g, \psi]|_{\lambda=0}$, which is linear w.r.t. an arbitrary variation $\delta g_{\mu\nu}(x) = \delta g_{\nu\mu}(x)$. It is therefore of the form indicated on the r.h.s.. The computation of $T^{\mu\nu}$ may require partial integrations.

Let X be a vector field vanishing on ∂D and φ_t the corresponding flow. Then

$$\int_{\varphi_{-t}(D)} \mathcal{L}(\varphi_t^*g, \varphi_t^*\psi, \nabla_{\varphi_t^*g}\varphi_t^*\psi) \sqrt{-\varphi_t^*g} d^4x$$

is independent of t by (5.25). We compute its (vanishing) derivative at $t = 0$ for ψ being a solution of (5.26):

$$\begin{aligned} \delta g &= \frac{d}{dt} \varphi_t^*g|_{t=0} = L_X g, \\ \delta g_{\mu\nu} &= X^\lambda g_{\mu\nu,\lambda} + g_{\lambda\nu} X^\lambda_{,\mu} + g_{\mu\lambda} X^\lambda_{,\nu} \\ &= X_{\mu;\nu} + X_{\nu;\mu} , \end{aligned} \quad (5.27)$$

since the expressions on both sides of the last equality are tensorial, agree in normal coordinates, and hence in any. Thus, by $\delta_\psi S = 0$ and $\varphi_{-t}(D) = D$, that derivative is

$$- \int_D \frac{1}{2} \underbrace{T^{\mu\nu} (X_{\mu;\nu} + X_{\nu;\mu})}_{T^{\mu\nu} X_{\mu;\nu} = (T^{\mu\nu} X_\mu)_{;\nu} - T^{\mu\nu}_{;\nu} X_\mu} \sqrt{-g} d^4x = 0 .$$

The first term under the brace yields a vanishing boundary term, see (5.24) for $W^\nu = T^{\mu\nu} X_\mu$. We conclude

$$T^{\mu\nu}_{;\nu} = 0 ,$$

as a consequence of the equations of motion for ψ alone, i.e. without appealing to the field equations. The full action for those is, by the way,

$$S_D = \int_D (R + 2\Lambda - 2\kappa\mathcal{L}) \sqrt{-g} d^4x ;$$

note however that if the expression for \mathcal{L} contains ∇ , the Palatini variational method may not work.

Example. The electromagnetic field. The basic field is the 4-potential A_μ and the Lagrangian in absence of sources is

$$\mathcal{L} = -\frac{1}{4}F_{\mu\nu}F^{\mu\nu} = -\frac{1}{4}F_{\mu\nu}F_{\sigma\rho}g^{\mu\sigma}g^{\nu\rho}$$

with $F_{\mu\nu} = A_{\nu;\mu} - A_{\mu;\nu} = A_{\nu,\mu} - A_{\mu,\nu}$. Thus

$$\frac{\partial \mathcal{L}}{\partial A_\nu} = 0, \quad \frac{\partial \mathcal{L}}{\partial A_{\nu;\mu}} = -\frac{1}{4}F_{\sigma\rho}g^{\mu\sigma}g^{\nu\rho} \cdot 4 = -F^{\mu\nu},$$

whence (5.26) are the Maxwell equations $F^{\mu\nu}{}_{;\mu} = 0$ for the freely falling field, cf. (4.12). In order to compute the energy momentum tensor, note that

$$\delta_g \int_D \mathcal{L} \sqrt{-g} d^4x = \int_D (\delta_g \mathcal{L} + \frac{1}{2} \mathcal{L} g^{\alpha\beta} \delta g_{\alpha\beta}) \sqrt{-g} d^4x$$

with

$$\begin{aligned} \delta_g \mathcal{L} &= -\frac{1}{4} F_{\mu\nu} F_{\sigma\rho} (g^{\mu\sigma} \delta g^{\nu\rho} + g^{\nu\rho} \delta g^{\mu\sigma}) \\ &= -\frac{1}{2} F_{\mu\nu} F_{\sigma\rho} g^{\mu\sigma} \delta g^{\nu\rho} \\ &= \frac{1}{2} F_{\mu\nu} F^\mu{}_\rho g^{\nu\alpha} g^{\rho\beta} \delta g_{\alpha\beta} \\ &= \frac{1}{2} F_\mu{}^\alpha F^{\mu\beta} \delta g_{\alpha\beta}. \end{aligned}$$

Thus,

$$\begin{aligned} T^{\alpha\beta} &= -F_\mu{}^\alpha F^{\mu\beta} - \mathcal{L} g^{\alpha\beta} \\ &= F^\alpha{}_\mu F^{\mu\beta} - \frac{1}{4} (F_{\nu\mu} F^{\mu\nu}) g^{\alpha\beta}, \end{aligned}$$

cf. (4.14).

6. Homogeneous isotropic universe

We shall discuss the field equations for a perfect fluid and construct a solution for dust (Friedmann 1922). It is assumed that the distribution of matter and the geometry of space are homogeneous and isotropic (cosmological principle).

6.1. The ansatz

We assume that time slices (in suitable coordinates) are 3-dimensional spaces of constant curvature. We introduce these spaces as submanifolds M_0 in an affine \mathbb{R}^4 (which bears no relation with spacetime!), given in terms of coordinates x^1, \dots, x^4 :

$$k((x^1)^2 + (x^2)^2 + (x^3)^2) + (x^4)^2 = R_0^2$$

with $k = 0, \pm 1$ and $R_0 > 0$. The metric g_0 on M_0 is the one induced by

$$(dx^1)^2 + (dx^2)^2 + (dx^3)^2 + k(dx^4)^2$$

(with $(dx^i)^2 = dx^i \otimes dx^i$).

k	M_0	curvature	geometry	symmetry group \mathcal{S}
+1	sphere (“closed”)	> 0	spherical	$O(4)$: orthogonal
0	plane	$= 0$	plane	$E(3)$: Euclidean
-1	hyperboloid (“open”)	< 0	hyperbolic	$L(4)$: Lorentz

These manifolds are highly symmetric: There is a group \mathcal{S} of transformations S with

$$S(M_0) = M_0, \quad S^*g_0 = g_0, \quad (6.1)$$

(isometries of M_0). Here S acts according to $(Sx)^i = S^i_j x^j$, ($i = 1, \dots, 4$) for $S \in O(4), L(4)$ and according to $(Sx)^i = R^i_j x^j + a^i$, ($i = 1, \dots, 3$) for $S = (R, a) \in E(3)$. Any two points in M_0 and any two normalized vectors in $T_p(M_0)$ are equivalent in terms of the symmetry: M_0 is homogeneous and isotropic. Any space of signature $(+, +, +)$ and of constant curvature is (without proof) one of the above “up to the topology” (example for $k = 0$: torus $(\mathbb{R}/\mathbb{Z})^3$ instead of \mathbb{R}^3).

Charts:

A: coordinates (x^1, x^2, x^3) with map:

$$x^4 = \sqrt{R_0^2 - kr^2} \equiv w(r), \quad r = \sqrt{(x^1)^2 + (x^2)^2 + (x^3)^2}.$$

With $\partial x^4 / \partial x^i = -kx^i / w$ we have

$$g_0 = \sum_{i=1}^3 (dx^i)^2 + \frac{k}{R_0^2 - kr^2} \sum_{i,j=1}^3 x^i x^j dx^i dx^j. \quad (6.2)$$

B: coordinates (r, θ, φ) with map:

$$x^1 = r \cos \theta \cos \varphi, \quad x^2 = r \cos \theta \sin \varphi, \quad x^3 = r \sin \theta, \quad x^4 = w(r).$$

With

$$(dr)^2 + k(dx^4)^2 = (1 + kw'^2)dr^2 = \frac{1}{1 - k(r/R_0)^2}dr^2$$

we have

$$g_0 = \frac{1}{1 - k(r/R_0)^2}dr^2 + r^2(d\theta^2 + \sin^2 \theta d\varphi^2). \quad (6.3)$$

A variant thereof is obtained by replacing r with χ according to

$$\frac{r}{R_0} = \begin{cases} \sin \chi, & (\chi \in [0, \pi], k = 1), \\ \chi, & (\chi \in [0, \infty), k = 0), \\ \text{sh } \chi, & (\chi \in [0, \infty), k = -1), \end{cases} \quad (6.4)$$

$r/R_0 = \text{sinn } \chi$ for short. Then $w(r)/R_0 = \cos \chi$, resp. 1, $\text{ch } \chi$ and

$$g_0 = R_0^2(d\chi^2 + \text{sinn}^2 \chi(d\theta^2 + \sin^2 \theta d\varphi^2)). \quad (6.5)$$

For $k = 1$ the two charts (but not M_0) have a singularity at $r = R_0$.

We now combine these spatial geometries with a time interval $t \in I \subset \mathbb{R}$ and obtain a **spacetime** $M = I \times M_0$ with **metric** ($c = 1$)

$$g = dt^2 - a^2(t)g_0. \quad (6.6)$$

Remark: Different values of R_0 in (6.2) describe the same class of spacetimes (6.6), because a rescaling of R_0 amounts to one of $a(t)$. We thus set $R_0 = 1$, ($k/R_0^2 \rightsquigarrow k$). Even then and for $k = 0$ a rescaling of the Euclidean metric remains possible, since it can be absorbed by a rescaling of coordinates.

The only velocity field u compatible with isotropy has components

$$u^\mu = (1, 0, 0, 0)$$

w.r.t. chart A. It generates geodesics, $\nabla_u u = 0$, since by symmetry (6.1) the l.h.s. equals λu , and $(u, \nabla_u u) = 0$ implies $\lambda = 0$.

In the case of dust, particles of matter (galaxies or observers therein) shall have constant spatial coordinates (x^1, x^2, x^3) (comoving coordinates) and thus velocity u ; in the case of a perfect fluid the same is locally true for the fluid as a whole, rather than of its constituent particles. Similarly homogeneity demands $\varepsilon = \varepsilon(t)$. The **energy-momentum tensor** of a perfect fluid is $T = (\varepsilon + p)u \otimes u - pg$, cf. (5.4).

6.2. Expansion

$t = x^0$ is the proper time of a particle at rest in charts A, B and the spatial distance $d(t)$ of any two of them is proportional to $a(t)$. Hence the expansion rate

$$\frac{\dot{d}(t)}{d(t)} = \frac{\dot{a}(t)}{a(t)} =: H(t) \quad (6.7)$$

is the same for all pairs of particles. That is known as **Hubble's law**: The velocity of particles to one another is proportional to their distance, $\dot{d}(t) = H(t)d(t)$.

A further important witness to the expansion of the universe is the redshift of spectral lines. We consider a sender (e.g. an atom) (1) and a receiver (2) on (time-like) world lines. Two light signals, emitted by (1) with a proper time difference $\Delta\tau^{(1)}$, are received by (2) with proper time difference $\Delta\tau^{(2)}$. For monochromatic light, the ratio of the received to the emitted frequency is

$$\frac{\nu_2}{\nu_1} = \frac{\Delta\tau^{(1)}}{\Delta\tau^{(2)}}.$$

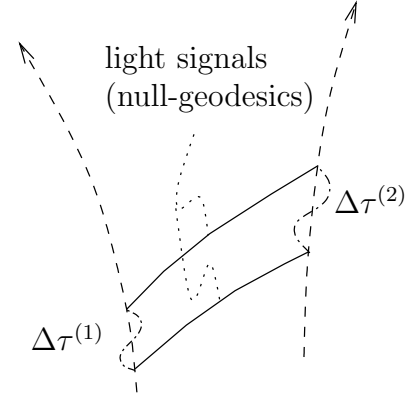

Atomic spectra just get rescaled and thus remain recognizable. Both ν_1 and ν_2 can hence be determined by observation.

In the homogeneous, isotropic universe we consider sender and receiver at rest w.r.t. matter, i.e., w.r.t. their galaxies. Let the sender S have the (fixed) coordinates $(r_1, \theta_1, \varphi_1)$ w.r.t. chart B, and the receiver $r_2 = 0$. A light ray from (1) to (2) runs spatially radially along $\theta, \varphi = \text{const}$, since this is the only direction distinguished by those endpoints. By (6.6, 6.3) we thus have along the light ray

$$dt = a(t)R_0 \frac{dr}{w(r)}$$

and

$$\int_0^{r_1} \frac{dr}{w(r)} = R_0^{-1} \int_{t_1}^{t_2} \frac{dt}{a(t)} \quad (6.8)$$

where t_1 , resp. t_2 are the times of emission, resp. arrival of a wave trough. For the time differences Δt_i between two successive troughs (periods) we so get

$$\int_{t_1}^{t_2} \frac{dt}{a(t)} = \int_{t_1 + \Delta t_1}^{t_2 + \Delta t_2} \frac{dt}{a(t)},$$

i.e.

$$\frac{\Delta t_1}{a(t_1)} = \frac{\Delta t_2}{a(t_2)}.$$

Since $\Delta\tau^{(i)} = \Delta t_i$ (sender/receiver at rest) we have

$$\frac{\nu_2}{\nu_1} = \frac{a(t_1)}{a(t_2)}. \quad (6.9)$$

During a phase of expansion one has $a(t_2) > a(t_1)$, hence $\nu_2 < \nu_1$: redshift. The largest observed values (corresponding to very distant objects) yield $1 + z := \nu_1/\nu_2 \approx 8$. Here z is known as **redshift** parameter.

6.3. The Friedmann equations

We show that the field equations (5.17) can be satisfied by a suitable choice of functions $a(t)$, $\varepsilon(t)$. We will show this twice, using different charts and methods.

A: Because of the symmetry it suffices to fulfill the field equations at points $(t, 0, 0, 0)$. Since they contain derivatives of $g_{\mu\nu}$ only up to 2nd order, we shall retain of $g_{\mu\nu}(t, x_1, x_2, x_3)$ only terms up to 2nd order in \vec{x} :

$$g_{\mu\nu} = \left(\begin{array}{c|ccc} 1 & 0 & 0 & 0 \\ \hline 0 & & & \\ 0 & -a^2 (\delta_{ik} + kx^i x^k) & & \\ 0 & & & \end{array} \right) ,$$

hence:

$$\left. \begin{array}{l} g_{\mu\nu,\sigma} = 0 \quad \text{if } \mu = 0 \text{ or } \nu = 0 , \\ g_{ik,0} = -2a\dot{a} \delta_{ik} \\ g_{ik,l} = -a^2 k (x^i \delta_{kl} + x^k \delta_{il}) \end{array} \right\} \text{in linear approximation in } \vec{x}, \text{ for } l, i, k = 1, 2, 3 .$$

Accordingly, it will be enough to compute

$$\Gamma^\mu_{\sigma\nu} = \frac{1}{2} g^{\mu\rho} (g_{\sigma\rho,\nu} + g_{\nu\rho,\sigma} - g_{\sigma\nu,\rho}) .$$

to 1st order in \vec{x} . As for $g^{\mu\rho}$ the 0th order suffices, since the correction is of 2nd order.

Result: $\neq 0$ are only

$$\begin{aligned} \Gamma^0_{ii} &= a\dot{a} , \\ \Gamma^i_{i0} &= \Gamma^i_{0i} = \frac{\dot{a}}{a} , \\ \Gamma^i_{ll} &= kx^i . \end{aligned}$$

Example:

$$\begin{aligned} \Gamma^j_{il} &= \frac{1}{2} \left(-\frac{1}{a^2} \delta_{jk} \right) (-a^2 k) (x^i \delta_{kl} + x^k \delta_{il} + \underline{\underline{x^l \delta_{ki}}} + x^k \delta_{il} - \underline{x^i \delta_{kl}} - \underline{\underline{x^l \delta_{ik}}}) \\ &= k \delta_{jk} \delta_{il} x^k = k \delta_{il} x^j . \end{aligned}$$

Ricci tensor:

$$R_{\mu\nu} = R^\alpha_{\mu\alpha\nu} = \Gamma^\alpha_{\nu\mu,\alpha} - \Gamma^\alpha_{\alpha\mu,\nu} + \Gamma^\sigma_{\nu\mu} \Gamma^\alpha_{\alpha\sigma} - \Gamma^\sigma_{\alpha\mu} \Gamma^\alpha_{\nu\sigma} .$$

Result: $\neq 0$ are only

$$\begin{aligned} R_{00} &= -3\ddot{a}/a , \\ R_{jj} &= a\ddot{a} + 2\dot{a}^2 + 2k . \end{aligned}$$

($R_{ij} = R_{11} \cdot \delta_{ij}$ follows already by isotropy.)

Example:

$$R_{00} = R^\alpha_{0\alpha 0} = \underbrace{\Gamma^\alpha_{00,\alpha}}_0 - \underbrace{\Gamma^\alpha_{\alpha 0,0}}_{-3\left(\frac{\dot{a}}{a}\right)} + \underbrace{\Gamma^\sigma_{00}}_0 \Gamma^\alpha_{\alpha\sigma} - \underbrace{\Gamma^\sigma_{\alpha 0} \Gamma^\alpha_{0\sigma}}_{-3\left(\frac{\dot{a}}{a}\right)^2} = -3\ddot{a}/a ,$$

$$\begin{aligned} R_{jj} &= \Gamma^\alpha_{jj,\alpha} & &= (a\dot{a})' + 3k & & (\alpha = 0, 1, 2, 3) \\ &- \Gamma^\alpha_{\alpha j,j} & &= -k & & (\alpha = j) \\ &+ \Gamma^\sigma_{jj} \Gamma^\alpha_{\alpha\sigma} & &= a\dot{a} \cdot (3\dot{a}/a) & & (\sigma = 0, \alpha = j) \\ &- \Gamma^\sigma_{\alpha j} \Gamma^\alpha_{j\sigma} & &= -2a\dot{a} \cdot (\dot{a}/a) & & (\sigma = 0, \alpha = j \text{ or } \sigma = j, \alpha = 0) \\ &= a\ddot{a} + (1 + 3 - 2)\dot{a}^2 + 2k . \end{aligned}$$

Einstein tensor:

For the scalar curvature we find

$$R = R_{00} - \frac{1}{a^2}(R_{11} + R_{22} + R_{33}) = -\frac{6}{a^2}(a\ddot{a} + \dot{a}^2 + k) .$$

The Einstein tensor $G_{\mu\nu} = R_{\mu\nu} - \frac{1}{2}g_{\mu\nu}R$ is diagonal with

$$\begin{aligned} G_{00} &= \frac{3}{a^2}(\dot{a}^2 + k) , \\ G_{jj} &= -(2a\ddot{a} + \dot{a}^2 + k) . \end{aligned} \tag{6.10}$$

B: We use the Cartan calculus. **Basis of 1-forms:**

$$\left. \begin{aligned} e^0 &= dt \\ e^1 &= \frac{a}{w} dr \\ e^2 &= ar d\theta \\ e^3 &= ar \sin \theta d\varphi \end{aligned} \right\} g = g_{\mu\nu} e^\mu \otimes e^\nu , \quad g_{\mu\nu} = \begin{pmatrix} 1 & & & 0 \\ & -1 & & \\ & & -1 & \\ 0 & & & -1 \end{pmatrix} .$$

We have

$$\begin{aligned} de^0 &= 0 \\ de^1 &= \frac{\dot{a}}{w} dt \wedge dr = e^0 \wedge \frac{\dot{a}}{w} dr , \\ de^2 &= \dot{a} r dt \wedge d\theta + a dr \wedge d\theta , \\ &= e^0 \wedge (\dot{a} r d\theta) + e^1 \wedge (w d\theta) , \\ de^3 &= \dot{a} r \sin \theta dt \wedge d\varphi + a \sin \theta dr \wedge d\varphi + ar \cos \theta d\theta \wedge d\varphi , \\ &= e^0 \wedge (\dot{a} r \sin \theta d\varphi) + e^1 \wedge (w \sin \theta d\varphi) + e^2 \wedge (\cos \theta d\varphi) . \end{aligned} \tag{6.11}$$

Connection forms

Structure equations for $\omega^\mu{}_\nu$

$$\omega_{\mu\nu} + \omega_{\nu\mu} = dg_{\mu\nu} = 0 , \quad de^\mu = e^\nu \wedge \omega^\mu{}_\nu$$

(with $\omega_{\mu\nu} = g_{\mu\sigma}\omega^\sigma{}_\nu$). The solution can be guessed by comparison with (6.11) and it is unique by the theorem on p. 31:

$$\begin{aligned}\omega^\mu{}_\mu &= 0, & (\text{without summation convention}), \\ -\omega^2{}_3 &= \omega^3{}_2 = \cos\theta d\varphi, \\ -\omega^1{}_3 &= \omega^3{}_1 = w \sin\theta d\varphi, \\ \omega^0{}_3 &= \omega^3{}_0 = \dot{a}r \sin\theta d\varphi, \\ -\omega^1{}_2 &= \omega^2{}_1 = w d\theta, \\ \omega^0{}_2 &= \omega^2{}_0 = \dot{a}r d\theta, \\ \omega^0{}_1 &= \omega^1{}_0 = \frac{\dot{a}}{w} dr.\end{aligned}$$

Curvature forms

$$\Omega^\mu{}_\nu = d\omega^\mu{}_\nu + \omega^\mu{}_\sigma \wedge \omega^\sigma{}_\nu.$$

By $\omega_{\mu\nu} + \omega_{\nu\mu} = 0$ we have $\Omega_{\mu\nu} + \Omega_{\nu\mu} = 0$. Result:

$$\begin{aligned}\Omega^0{}_i &= \Omega^i{}_0 = \frac{\ddot{a}}{a} e^0 \wedge e^i, \\ -\Omega^j{}_i &= \Omega^i{}_j = \frac{k + \dot{a}^2}{a^2} e^i \wedge e^j.\end{aligned}$$

Example:

$$\begin{aligned}\Omega^1{}_0 &= d\omega^1{}_0 = \frac{\ddot{a}}{w} dt \wedge dr = \frac{\ddot{a}}{a} e^0 \wedge e^1, \\ \Omega^2{}_1 &= d\omega^2{}_1 + \omega^2{}_0 \wedge \omega^0{}_1 = w' dr \wedge d\theta + \frac{\dot{a}^2 r}{w} d\theta \wedge dr \\ &= \frac{1}{a^2} \underbrace{\left(\frac{ww'}{r} - \dot{a}^2 \right)}_{-k} e^1 \wedge e^2.\end{aligned}$$

The remaining $\Omega^i{}_j$ follow by isotropy (or by computation).

Ricci tensor:

$$R_{\mu\nu} = R^\alpha{}_{\mu\alpha\nu} = \Omega^\alpha{}_\mu(e_\alpha, e_\nu)$$

is diagonal because of $\Omega^\alpha{}_\mu \sim e^\alpha \wedge e^\mu$. One finds

$$\begin{aligned}R_{00} &= -\frac{3\ddot{a}}{a}, \\ R_{jj} &= \frac{\ddot{a}}{a} + \frac{2(k + \dot{a}^2)}{a^2} = \frac{a\ddot{a} + 2\dot{a}^2 + 2k}{a^2}.\end{aligned}$$

Scalar curvature:

$$R = R_{00} - (R_{11} + R_{22} + R_{33}) = -\frac{6}{a^2}(a\ddot{a} + \dot{a}^2 + k).$$

Einstein tensor:

$$G_{00} = \frac{3}{a^2}(\dot{a}^2 + k), \quad G_{jj} = -\frac{2a\ddot{a} + \dot{a}^2 + k}{a^2}. \quad (6.12)$$

Energy momentum: It is given by (5.4), both in chart A at $(t, 0, 0, 0)$ and w.r.t. the basis of 1-forms in chart B.

Friedmann equations: ($c = \kappa = 1$). After lowering indices the field equations read by (6.10), resp. (6.12), as well as by (5.4)

$$(\mu\nu) = (00) : \quad a(\dot{a}^2 + k) - \frac{1}{3}\Lambda a^3 = \frac{1}{3}\varepsilon a^3, \quad (6.13)$$

$$(\mu\nu) = (jj) : \quad 2a\ddot{a} + \dot{a}^2 + k - \Lambda a^2 = -pa^2. \quad (6.14)$$

Remarks 1) With $a(t), \varepsilon(t)$ also $a(t - t_0), \varepsilon(t - t_0)$ and $a(-t), \varepsilon(-t)$ are solutions.

2) The equations imply

$$\frac{d}{dt}\left(\frac{1}{3}\varepsilon a^3\right) = \dot{a}(\dot{a}^2 + k) + 2a\dot{a}\ddot{a} - \Lambda a^2\dot{a} = \dot{a}(2a\ddot{a} + \dot{a}^2 + k - \Lambda a^2) = -p\frac{d}{dt}\left(\frac{1}{3}a^3\right), \quad (6.15)$$

which is in analogy to the First Law of Thermodynamics in the form

$$dU = -pdV$$

valid for adiabatic processes. For $\dot{a}(t) \neq 0$ that equation may replace (6.14).

3) The First Law is equivalent to the integrability condition $0 = T^{\mu\nu}{}_{;\nu} = T^{\mu\nu}{}_{,\nu} + \Gamma^\nu{}_{\nu\rho}T^{\mu\rho} + \Gamma^\mu{}_{\nu\rho}T^{\rho\nu}$ for $\mu = 0$, since

$$T^{0\nu}{}_{;\nu} = \dot{\varepsilon} + 3\frac{\dot{a}}{a}\varepsilon + 3a\dot{a}\frac{p}{a^2} = \frac{1}{a^3}\left(\frac{d}{dt}(\varepsilon a^3) + p\frac{d}{dt}a^3\right).$$

Alternatively, (5.6) multiplied by $\sqrt{-g} = a^3$ states by (5.24): $(d/dt)(\varepsilon a^3) + p(da^3/dt) = 0$.

4) The equation of state $p = w\varepsilon$ stands for dust ($w = 0$), for isotropic electromagnetic radiation ($w = 1/3$) and for the cosmological term ($w = -1$). Then (6.15) implies by

$$\frac{d}{dt}(\varepsilon a^3) + w\varepsilon\frac{d}{dt}a^3 = a^{-3w}\frac{d}{dt}(\varepsilon a^3 \cdot a^{3w})$$

that

$$\varepsilon \propto a^{-3(1+w)}. \quad (6.16)$$

In combination of different fluids, the universe is dominated in the course of its expansion by fluids of successively smaller w : From radiation to dust to vacuum energy.

In the following we consider the case of dust in combination with Λ . Then $\varepsilon = \rho$, $p = 0$ and

$$\frac{1}{3}\rho a^3 = C = \text{const} > 0. \quad (6.17)$$

Thus

$$\dot{a}^2 - \frac{1}{3}\Lambda a^2 - \frac{C}{a} = -k, \quad (6.18)$$

$$2a\ddot{a} + \frac{C}{a} - \frac{2}{3}\Lambda a^2 = 0. \quad (6.19)$$

A static universe $a(t) = \text{const}$ requires $(2/3)\Lambda a^3 = C$, hence $\Lambda > 0$ and $k = +1$. The solution (Einstein 1917)

$$a = \Lambda^{-1/2}, \quad \rho = 2\Lambda \quad (6.20)$$

however is unstable, because any displacement from equilibrium would be enhanced by \ddot{a} according to (6.19).

The solutions depend on parameters Λ , C and on an initial condition $a(t_0)$. It is usual to choose t_0 as the present time and to express these quantities by means of properties of the present universe. To this end we reintroduce the scale R_0 ($k \rightsquigarrow k/R_0^2$). Division of (6.18) by $\dot{a}(t_0)^2$ ($\neq 0$, which rules out the equilibrium solution) yields

$$\left(\frac{\dot{a}(t)}{\dot{a}(t_0)}\right)^2 - \frac{1}{3}\Lambda\left(\frac{a(t)}{\dot{a}(t_0)}\right)^2 - \frac{1}{3}\frac{\rho(t_0)a(t_0)^3}{\dot{a}(t_0)^2 a(t)} = -\frac{k}{R_0^2 \dot{a}(t_0)^2}. \quad (6.21)$$

We now choose R_0 so that $a(t_0) = 1$, hence $\dot{a}(t_0) = H(t_0)$, and obtain

$$\frac{\dot{a}^2}{H^2} - (\Omega_\Lambda a^2 + \Omega_m a^{-1}) = 1 - \Omega_\Lambda - \Omega_m \equiv \Omega_k \quad (6.22)$$

with new parameters

$$H := H(t_0), \quad \Omega_\Lambda := \frac{\Lambda}{3H^2}, \quad \Omega_m := \frac{\rho(t_0)}{3H^2}. \quad (6.23)$$

The constant Ω_k has been determined by evaluation of the l.h.s. at $t = t_0$. Comparison with the one from (6.21) yields

$$k = -\text{sgn } \Omega_k, \quad R_0 = |\Omega_k|^{-1/2} H^{-1}. \quad (6.24)$$

Eq. (6.22) formally corresponds to the conservation of the energy Ω_k of a non-relativistic particle of mass $2/H^2$ moving in 1-dimension and in the potential $U(a) = -(\Omega_\Lambda a^2 + \Omega_m a^{-1})$. Changing H affects the motion $a(t)$ only through a linear reparametrization of t . Different types of motion occur depending on Ω_m, Ω_Λ . We distinguish cases by the sign of Ω_Λ (or Λ).

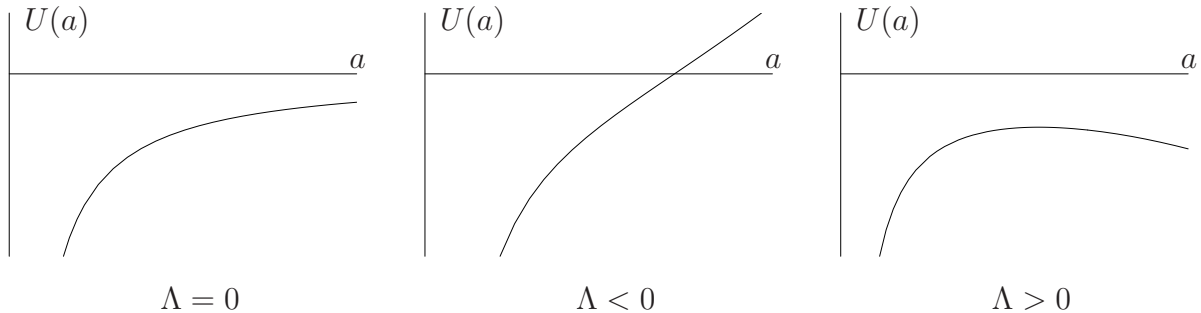

Most motions begin or end at $a = 0$: a “Big Bang” or a “Big Crunch”. This is a true singularity, since the scalar curvature diverges there: $R + 4\Lambda = -T = -\rho = -3C/a^3 \rightarrow \infty$ for $t \rightarrow 0$.

• $\Lambda = 0$:

$\Omega_m < 1$: unbounded expansion $a(t)$ with positive asymptotic velocity;

$\Omega_m = 1$: unbounded expansion with vanishing asymptotic velocity;

$\Omega_m > 1$: bounded expansion, then recollapse.

- $\Lambda < 0$: bounded expansion, then recollapse.

- $\Lambda > 0$: the potential $U(a)$ has a maximum $-3\Omega_\Lambda^{1/3}(\Omega_m/2)^{2/3}$ at $a = (\Omega_m/2\Omega_\Lambda)^{1/3}$. If it is located to the right of the present day value $a = 1$, i.e.,

$$\Omega_m > 2\Omega_\Lambda , \tag{6.25}$$

then the expansion is slowing down. A motion which is bounded above or below requires

$$1 - \Omega_\Lambda - \Omega_m < -3\Omega_\Lambda^{1/3}(\Omega_m/2)^{2/3} .$$

This can occur only for $\Omega_\Lambda + \Omega_m > 1$ and, if this inequality is barely satisfied, only if either Ω_Λ or Ω_m is small. In the first case, i.e. for small $(\Omega_m - 1)/\Omega_m > 0$ we have

$$\frac{\Omega_\Lambda}{\Omega_m} < 4\left(\frac{\Omega_m - 1}{3\Omega_m}\right)^3 + \dots .$$

Since there (6.25) applies, the motion is bounded above. In the second case, i.e. for small $(\Omega_\Lambda - 1)/\Omega_\Lambda > 0$ we have

$$\frac{\Omega_m}{\Omega_\Lambda} < 2\left(\frac{\Omega_\Lambda - 1}{3\Omega_\Lambda}\right)^{3/2} + \dots .$$

This corresponds to a motion bounded below: No Big Bang, but a contraction followed by an expansion.

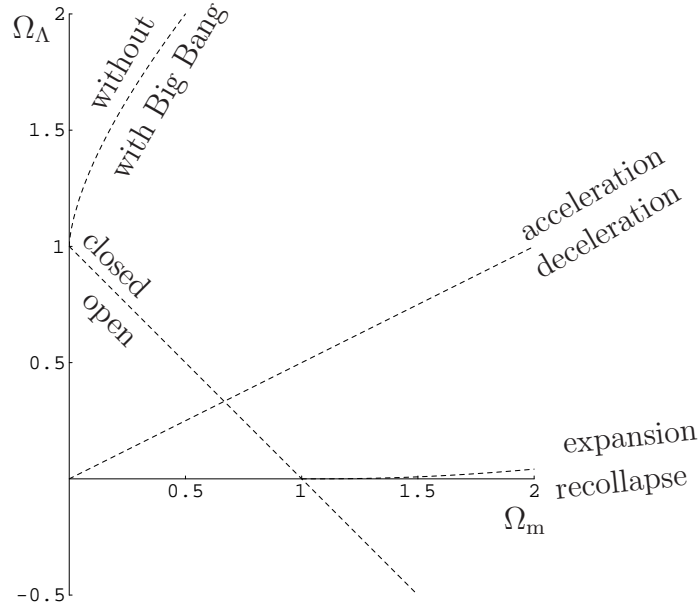

In the models with (6.25) one has $\ddot{a}(t) < 0$ in the past, whence $a(t)$ is concave, s. figure below on the left. The age t_0 of the universe is then bounded by $t_0 < H^{-1}$. In general we have by (6.22)

$$t_0 = H^{-1} \int_0^1 da \frac{1}{\sqrt{\Omega_k - U(a)}} ,$$

which cannot be evaluated in closed form. In the figure on the right t_0 is represented by level sets in units of the Hubble time H^{-1} .

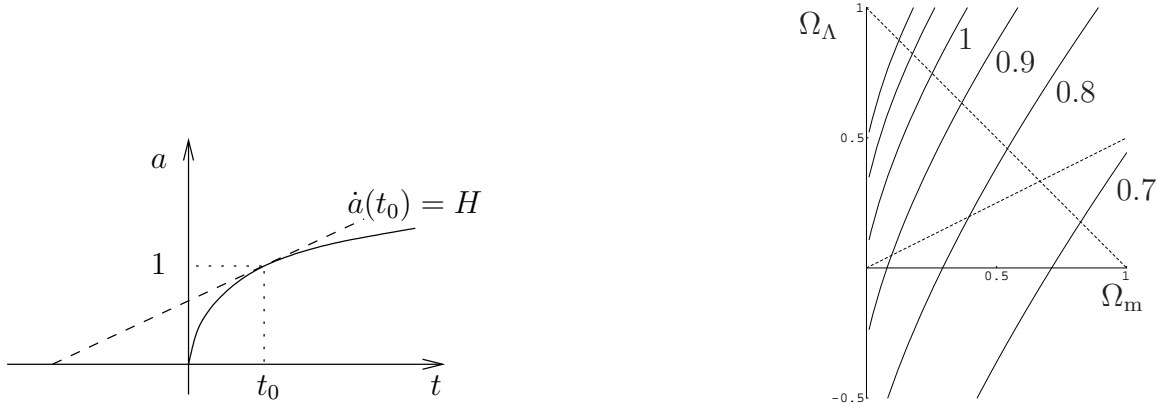

Special cases: The time dependence of $a(t)$ can be determined explicitly for (i) $C = 0$, $\Lambda > 0$ or (ii) $\Lambda = 0$. We use the equations of motion in the form (6.18, 6.17). (The replacement of (6.14) produces spurious solutions with $\dot{a} \equiv 0$, which are to be rejected.)

Solutions:

(i) Set $\alpha^2 = \Lambda/3$.

$$a(t) = \alpha^{-1} \begin{cases} \text{ch } \alpha t, & (k = +1), \\ e^{\alpha t}, & (k = 0), \\ \text{sh } \alpha t, & (k = -1). \end{cases}$$

In the exponentially expanding universe with $k = 0$ (de Sitter 1917), space is invariant under translations of time, because $t \mapsto t - t_0$ amounts to a rescaling of the coordinates of M_0 , cf. remark on p. 51.

(ii) ($a = 0$ at $t = 0$)

$$k = +1 : \quad \begin{cases} a = \frac{C}{2}(1 - \cos \eta), \\ t = \frac{C}{2}(\eta - \sin \eta), \end{cases} \quad (0 < \eta < 2\pi), \quad (6.26)$$

$$k = 0 : \quad a = \left(\frac{9C}{4}\right)^{1/3} t^{2/3} \quad (0 < t < \infty),$$

$$k = -1 : \quad \begin{cases} a = \frac{C}{2}(\text{ch } \eta - 1), \\ t = \frac{C}{2}(\text{sh } \eta - \eta), \end{cases} \quad (0 < \eta < \infty). \quad (6.27)$$

The case $k = 0$ is known as Einstein–de Sitter universe. **Proof:** By explicit computation

(' = d/dη). For k = +1:

$$\dot{a} = \frac{a'(\eta)}{t'(\eta)} = \frac{\sin \eta}{1 - \cos \eta},$$

$$\dot{a}^2 - \frac{C}{a} + k = \frac{\sin^2 \eta}{\underbrace{(1 - \cos \eta)^2}_{\frac{1 + \cos \eta}{1 - \cos \eta}}} - \frac{2}{1 - \cos \eta} + 1 = 0.$$

Für k = 0:

$$\dot{a} = \left(\frac{9C}{4}\right)^{1/3} \frac{2}{3} t^{-1/3},$$

$$\dot{a}^2 = \left(\frac{4}{9}\right)^{1/3} C^{2/3} t^{-2/3} = C/a.$$

For k = -1: analogous to k = +1. □

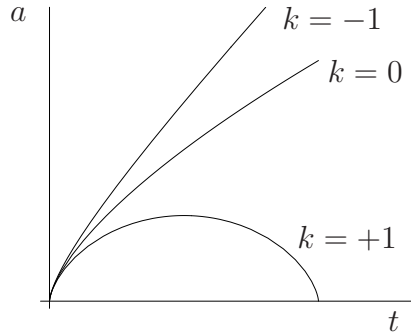

6.4. Which universe?

Astrophysical observations allow to determine the parameters in eq. (6.22), i.e. H and more recently also Ω_Λ , Ω_m . The following account is simplified.

The Hubble constant $H = \dot{a}(t_0)/a(t_0)$ is determined by the redshift z of light of distant galaxies, which is emitted at t_s and received at t_0 . We expand (6.9) in powers of the time of flight $t_0 - t_s$, which is assumed small in comparison to the age of the universe. With

$$\begin{aligned} a(t_s) &= a(t_0) - \dot{a}(t_0)(t_0 - t_s) + \frac{1}{2}\ddot{a}(t_0)(t_0 - t_s)^2 + \dots \\ &= a(t_0)\left(1 - H \cdot (t_0 - t_s) - \frac{1}{2}H^2q \cdot (t_0 - t_s)^2 + \dots\right), \end{aligned}$$

where $q := -a(t_0)\ddot{a}(t_0)\dot{a}(t_0)^{-2}$ is the dimensionless deceleration parameter, we obtain

$$1 + z = \frac{a(t_0)}{a(t_s)} = 1 + H \cdot (t_0 - t_s) + H^2\left(1 + \frac{1}{2}q\right)(t_0 - t_s)^2 + \dots$$

The distance d between receiver and sender at time t_0 is by (6.8)

$$d = a(t_0)R_0 \int_0^r \frac{dr'}{w(r')} = a(t_0) \int_{t_s}^{t_0} \frac{dt}{a(t)} = (t_0 - t_s) + \frac{1}{2}H \cdot (t_0 - t_s)^2 + \dots$$

After eliminating $t_0 - t_s$ from the two equations we end up with the **distance-redshift** relation:

$$z = Hd + \frac{1}{2}(1+q)(Hd)^2 + \dots$$

The lowest order corresponds to a Doppler shift of $z = \dot{d}(t_0) = Hd(t_0)$, see (6.7). A set of data (z, d) would yield H and, if sufficiently accurate, q . This is of indirect usefulness, since today's distance d between source and observer is not directly accessible to observation, but can be so determined. In a Minkowski spacetime the flux of light f (energy per unit time and area; apparent magnitude) coming from a source of intensity L (absolute luminosity) at a fixed distance d from the observer is

$$f = \frac{L}{4\pi d^2}.$$

In a Friedmann universe this remains true at leading order, where $d = z/H$. In higher orders the correction are described by the **magnitude-redshift** relation (see exercises):

$$f = \frac{LH^2}{4\pi z^2} (1 - (1-q)z + O(z^2)), \quad (z \rightarrow 0).$$

Data (f, L, z) are available, because of some stars of known absolute luminosity (standard candles: Cepheids, Supernovae of type Ia). Fitting them to the relation yields $H = 70.4 \pm 1.4$ (km/s)/Megaparsec, (1 Megaparsec = $3.26 \cdot 10^6$ light years), or $H^{-1} = 13.7 \cdot 10^9$ years, at lowest order, but also $q = -0.55$ at higher ones. That in turn determines a combination of Ω_Λ, Ω_m : Differentiating (6.22), resp. (6.19), shows $2q = \Omega_m - 2\Omega_\Lambda$.

The **cosmic microwave background** (CMB) is electromagnetic radiation with the spectral distribution of that emitted by a black body of temperature 2.73 K. It reaches us with nearly isotropic intensity and originates from a time t_s (time of last scattering), when nuclei and electrons became cool enough (~ 3000 K) to bind to neutral H- and He atoms. As a result matter became transparent, radiation decoupled and has since then been redshifted by a factor $1+z \approx 3000 \text{ K}/2.7 \text{ K} \approx 1100$. From (6.22) we get $H(t_s)^2 \approx H^2 \Omega_m (1+z)^3$ and $1+z \approx z$. Deviations from isotropy in the intensity distribution ($\sim 10^{-5}$) have a characteristic correlation length

$$\Delta s \approx 2H(t_s)^{-1}, \quad (6.28)$$

which corresponds to the radius of the horizon at time t_s (see (6.32) below) and spans today an angle $\Delta\varphi \approx 1^\circ$ on the sky (as seen e.g. with WMAP). Now $z, \Delta s, \Delta\varphi$ allow to infer the geometry k of the universe: Two directions, which for us at $\vec{x} = 0$ are separated by $\Delta\varphi$, differ by the same angle also in the chart B . Hence $\Delta s = a(t_s)r\Delta\varphi$, cf. (6.3), with $a(t_s) = z^{-1}$. We conclude

$$\frac{r}{R_0} = 2 \left(\frac{|\Omega_k|}{\Omega_m} \right)^{1/2} z^{-1/2} (\Delta\varphi)^{-1} \quad (6.29)$$

by using the above for r and (6.24) for R_0 . Setting $r/R_0 = \text{sinn } \chi$, cf. (6.4), we have $d\chi = dr/w(r)$ and by (6.8)

$$\chi = R_0^{-1} \int_{t_s}^{t_0} \frac{dt}{a(t)} = R_0^{-1} \int_{a(t_s)}^1 \frac{da}{a(t)\dot{a}(t)} = |\Omega_k|^{1/2} \int_{(1+z)^{-1}}^1 \frac{da}{a\sqrt{\Omega_k - U(a)}}. \quad (6.30)$$

The equations (6.29, 6.30) constrain a further combination of Ω_Λ , Ω_m : $\Omega_\Lambda + \Omega_m = 1.02 \pm 0.02$. Recently the intensity of the anisotropy at Δs has been measured, from which also Ω_m can be determined:

$$\Omega_m = 0.27 \pm 0.02, \quad \Omega_\Lambda = 0.73 \pm 0.02,$$

resp. $\rho(t_0) = 2.6 \cdot 10^{-27} \text{ kg m}^{-3}$, $\Lambda = 1.3 \cdot 10^{-52} \text{ m}^{-2}$ from (6.23). From the figure on p. 59 the age of the universe can then be read off as $t_0 = (13.7 \pm 0.1) \cdot 10^9$ years. One should add that baryonic matter only contributes 0.04 to Ω_m , the rest being dark matter of unknown kind.

6.5. The causality and flatness problems

In the metric (6.6) we trade t for conformal time η according to $dt = R_0 a(t) d\eta$ (cf. the special cases (6.26, 6.27)). Then, by (6.5),

$$g = R_0^2 a^2(t) (d\eta^2 - (d\chi^2 + \text{sinn}^2 \chi (d\theta^2 + \sin^2 \theta d\varphi^2))). \quad (6.31)$$

The range of η has a lower bound, which may be normalized at $\eta = 0$ by

$$\eta = R_0^{-1} \int_0^t \frac{dt'}{a(t')},$$

provided the integral is convergent at $t' = 0$. For the case of a fluid with equation of state $p = w\rho$, this amounts to $w > -1/3$; in fact in the limit $a \rightarrow 0$ eq. 6.13 reduces to $\dot{a}^2 \propto a^{-(1+3w)}$ by (6.16). It has solution $a \propto t^\alpha$, ($t \rightarrow 0$) with $\alpha = (2/3)(1+w)^{-1}$ and the condition for convergence, $\alpha < 1$, is as stated. Moreover,

$$\eta \approx \frac{2}{1+3w} (R_0 \dot{a})^{-1} \quad (t \rightarrow 0).$$

Geodesics ending at $\chi = 0$ come in radially ($d\theta = d\varphi = 0$) and for them the metric is conformally equivalent to the Minkowski metric $d\eta^2 - d\chi^2$. In particular, null geodesics run at $\pm 45^\circ$ in the (η, χ) -plane.

The particle horizon at P separates world lines that can be seen at P from those that can not. By the time η , the comoving matter at $\chi = 0$ is causally connected to that at χ only for $\chi \leq \eta$ (or, indirectly, $\chi \leq 2\eta$), which then is at distances at most

$$d = R_0 a(t) \eta = \frac{2}{1+3w} \frac{a(t)}{\dot{a}(t)} = \frac{2}{1+3w} H(t)^{-1}. \quad (6.32)$$

That distance with $t = t_s$ (time of last scattering) is seen as a characteristic correlation length in the CMB radiation, see (6.28) for $w = 0$. However that radiation is nearly homogeneous on all of the sky and hence over regions which had no common past. This **causality problem** of Friedmann cosmologies can be evaded by assuming that the earliest phase of the evolution is dominated by $w \approx -1$ (inflation), by which the range of η becomes unbounded below, or at least provides a scale (6.32) extending over the whole universe (accessible today) by the time inflation ends.

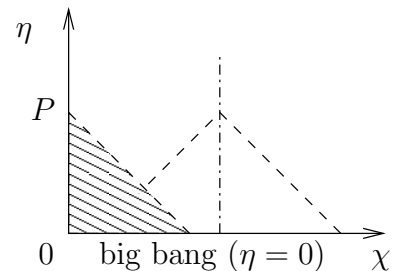

A further difficulty is seen from the flatness parameter, see (6.24),

$$\Omega_k = -\frac{k}{R_0^2 \dot{a}(t_0)^2},$$

as expressed in terms of present day properties. In the past the corresponding quantity was $\Omega_k(t) = -k/R_0^2 \dot{a}(t)^2$, whence

$$\frac{\Omega_k(t)}{\Omega_k} = \frac{\dot{a}(t_0)^2}{\dot{a}(t)^2} = \frac{H^2}{\dot{a}^2} = \frac{1}{\Omega_k + \Omega_\Lambda a^2 + \Omega_m a^{-1}}$$

by (6.22). Moving backward in time, $a(t) \rightarrow 0$, we have $\Omega_k(t)/\Omega_k \rightarrow 0$ because of $\Omega_m > 0$: the universe must even have been a lot flatter than it is today ($\Omega_k = 0.02 \pm 0.02$). This looks like an exceptional initial condition (**flatness problem**). Here too inflation provides a remedy: By the same equation, that initial condition could in fact be the end of a forward evolution with $\Omega_\Lambda > 0$ (and hence growing $a(t)$) out of a an even earlier, generic condition. That Ω_Λ , coming from a conjectured fluid with $w \approx -1$ (inflaton field), is different from the cosmological constant and much larger than the latter.

6.6. Redshift and symmetries

Out of symmetries one can sometimes determine ν_2/ν_1 without having to determine null geodesics. Geodesics are determined by the variational principle

$$\delta \int_{(1)}^{(2)} L d\lambda = 0, \quad L = \frac{1}{2} g(\dot{x}, \dot{x})$$

with fixed endpoints $(x^{(i)}, \lambda^{(i)})_{i=1,2}$. If only the $\lambda^{(i)}$ are fixed we have

$$\delta \int_{(1)}^{(2)} L d\lambda = (p, \delta x) \Big|_{(1)}^{(2)}, \quad (6.33)$$

with

$$p_\mu = \frac{\partial L}{\partial \dot{x}^\mu} = g_{\mu\nu} \dot{x}^\nu = \dot{x}_\mu.$$

This follows from the Euler-Lagrange equation $d(p, \delta x)/d\lambda = \delta L$.

For null geodesics ($L = 0$) we then find with $\delta x^{(i)} = u^{(i)} \delta \tau^{(i)}$ (cf. figure on p. 52) and $u = 4$ -velocity of sender/receiver.

$$\frac{\nu_2}{\nu_1} = \frac{\delta \tau^{(1)}}{\delta \tau^{(2)}} = \frac{(u^{(2)}, p)}{(u^{(1)}, p)}. \quad (6.34)$$

Let now φ_s be a 1-parameter group of isometries of M , cf. (6.1). The generating vector field K of φ_t is called a **Killing field**:

$$L_K g = 0.$$

We then have along any geodesic

$$(K, p) = \text{konstant}. \quad (6.35)$$

Proof: (This is Noether's theorem from Mechanics.) By assumption, L is invariant under variations $x_t = \varphi_t(x)$. For those, $\delta x = K$ and (6.33) reads $0 = (p, K)|_{(1)}^{(2)}$. \square

We shall henceforth consider the situation, where at (1) and (2) the Killing vectors lies in the plane spanned by u and p :

$$K = \alpha u + \beta p . \quad (6.36)$$

From $\beta p = -\alpha u + K$, as well as from $(u, u) = 1$, $(p, p) = 0$ we get

$$0 = (\beta p, \beta p) = \alpha^2 - 2\alpha(K, u) + (K, K) ,$$

i.e.

$$\alpha = (K, u) \pm \sqrt{(K, u)^2 - (K, K)} . \quad (6.37)$$

Together with $(K, p) = \alpha(u, p)$ and (6.34, 6.35) we obtain

$$\frac{\nu_2}{\nu_1} = \frac{(K, p)_2}{(K, p)_1} . \quad \frac{\alpha_1}{\alpha_2} = \frac{\alpha_1}{\alpha_2} .$$

Special cases:

i) $K \parallel u$: In this case $\beta = 0$ and $(K, K) = \alpha^2$ (or (6.37)) implies

$$\frac{\nu_2}{\nu_1} = \frac{(K, K)_1^{1/2}}{(K, K)_2^{1/2}}$$

ii) $K \perp u$: In this case $\alpha = \pm[-(K, K)]^{1/2}$ and

$$\frac{\nu_2}{\nu_1} = \frac{[-(K, K)_1]^{1/2}}{[-(K, K)_2]^{1/2}} . \quad (6.38)$$

Applications:

1) **Cosmological redshift** in the homogeneous isotropic universe (6.6). Given a null geodesic $(t(\lambda), x(\lambda)) \in I \times M_0 = M$ we claim that $x(\lambda)$ is a geodesic, though not one with an affine parameterization. To see this we vary $x(\lambda)$ with fixed endpoints in M_0 and promote that family to one of spacetime curves with $L = 0$ by setting $dt/d\lambda = a(t)[g_0(\dot{x}, \dot{x})]^{1/2}$. For that one, one can only require $\delta t^{(1)} = 0$. The same follows for the other endpoint, $\delta t^{(2)} = 0$, because of (6.9) and of $(p, \delta x)|_{(i)} = p^0 \delta t|_{(i)}$. This then extends to $\delta \eta^{(i)} = 0$ for any function $\eta(t)$. Defining it by $d\eta = dt/a(t)$, we get

$$0 = \delta \eta \Big|_{(1)}^{(2)} = \delta \int_{(1)}^{(2)} \frac{d\eta}{d\lambda} d\lambda = \delta \int_{(1)}^{(2)} [g_0(\dot{x}, \dot{x})]^{1/2} d\lambda .$$

Let $\varphi_s : M_0 \rightarrow M_0$ be a 1-parameter group of isometries ($\varphi_s^* g_0 = g_0$) with generating field K . They become isometries $M \rightarrow M$ with corresponding Killing field on M by means of

$$\varphi_s(t, q) = (t, \varphi_s(q)) , \quad K_{(t, q)} = (0, K_q) ,$$

($q \in M_0$). Let $q_1, q_2 \in M_0$ be the positions of the sender, resp. of the receiver at rest. Because of the symmetry of M_0 , the geodesic $x(\lambda)$ is the orbit of a Killing field K_q , with $K_q \parallel \dot{x}$ and hence (6.36). Moreover we are in case ii), so that (6.38) applies. Now,

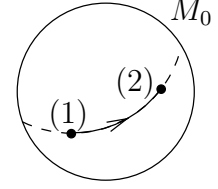

$$g(K, K) = -a(t)^2 g_0(K, K), \quad g_0(K, K)_2 = g_0(K, K)_1,$$

the latter holding true because of

$$\frac{d}{ds} g_0(K, K)_{\varphi_s(q)} \Big|_{s=0} = K g_0(K, K) = \underbrace{L_K g_0(K, K)}_{=0} + 2g_0(\underbrace{[K, K]}_{=0}, K) = 0.$$

Hence

$$\frac{\nu_2}{\nu_1} = \frac{a(t_1)}{a(t_2)},$$

as in (6.9).

2) **Gravitational redshift** in a **stationary metric**. In suitable coordinates we have

$$g_{\mu\nu,0} = 0, \quad (\partial/\partial x^0 \text{ timelike}).$$

Then, the vector field $K = \partial/\partial x^0 = (1, 0, 0, 0)$ is Killing:

$$(L_K g)_{\mu\nu} = \underbrace{K^\lambda g_{\mu\nu,\lambda}}_{g_{\mu\nu,0}=0} + g_{\lambda\nu} \underbrace{K^\lambda_{,\mu}}_{=0} + g_{\mu\lambda} \underbrace{K^\lambda_{,\nu}}_{=0} = 0. \quad (6.39)$$

For observers at rest we have i):

$$\frac{\nu_2}{\nu_1} = \frac{g_{00}(\vec{x}_1)^{1/2}}{g_{00}(\vec{x}_2)^{1/2}},$$

as in (4.21).

3) **Longitudinal Doppler effect** in SR: receiver at rest, sender with velocity $\vec{\beta}$, whence $u^{(1)} = \gamma(1, \vec{\beta})$, which is directed (a) towards or (b) away from the receiver. For the metric $g_{\mu\nu} = \eta_{\mu\nu}$ any constant vector field is Killing. For $K = (1, 0, 0, 0)$ we have (6.36) and $\alpha_2 = 1$, $(K, u^{(1)}) = \gamma$,

$$\frac{\nu_2}{\nu_1} = \alpha_1 = \gamma \pm \sqrt{\gamma^2 - 1} = \gamma(1 \pm \beta) = \sqrt{\frac{1 \pm \beta}{1 \mp \beta}},$$

depending on the cases (a,b).

7. The Schwarzschild-Kruskal metric

7.1. Stationary and static metrics

Let φ_s be a 1-parameter group of isometries of M . Its generating vector field K is then called a **Killing field**. By (1.18) this is tantamount to

$$L_K g = 0 .$$

A metric is called (locally) **stationary**, if relatively to a suitable chart

$$g_{\mu\nu,0} = 0 , \quad (\partial/\partial x^0 \text{ timelike}) . \quad (7.1)$$

Then $K = \partial/\partial x^0$ is a Killing field by (6.39).

Converse: g is stationary, if there exists a timelike Killing field K :

$$L_K g = 0 ; \quad (K, K) > 0 .$$

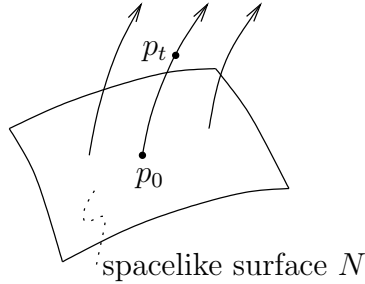

Proof: By construction of a chart, where (7.1) applies. Let φ_t be the flow generated by K ; x^1, x^2, x^3 arbitrary coordinates of $p_0 \in N$; and

$$(t, x^1, x^2, x^3)$$

the coordinates of $p_t = \varphi_t(p_0)$. Thus $K^\mu = (1, 0, 0, 0)$ in this chart, whence $L_K g = 0$ equivalent to $g_{\mu\nu,0} = 0$ (cf. (6.39)). \square

A metric is called (locally) **static**, if in a chart $(\vec{x} = (x^1, x^2, x^3))$

$$g_{\mu\nu} dx^\mu dx^\nu = g_{00}(\vec{x})(dx^0)^2 + \sum_{i,k=1}^3 g_{ik}(\vec{x}) dx^i dx^k$$

with $g_{00} > 0$. Then $K^\mu = (1, 0, 0, 0)$ is a Killing field. Let $\widehat{K} = gK$ be the corresponding 1-form $K_\mu = (g_{00}, 0, 0, 0)$. Then $\widehat{K} = g_{00} dx^0$, implying $d\widehat{K} = dg_{00} \wedge dx^0$ and

$$\widehat{K} \wedge d\widehat{K} = 0 . \quad (7.2)$$

Converse: A metric is static, if there exists a timelike Killing field K with $\widehat{K} \wedge d\widehat{K} = 0$ (proof, see below).

The significance of (7.2) arises from the following: a preliminary remark, a question, and a theorem. Let a vector field X with $X_p \neq 0$, ($p \in M$) be given on M ; then $V_p = \{\lambda X_p \mid \lambda \in \mathbb{R}\} \subset T_p M$ is a linear subspace of dimension 1. Manifestly, there is a family of curves γ such that $\dot{\gamma}_p \in V_p$; indeed, the integral curves of X . Let now instead a 1-form ω with $\omega_p \neq 0$, ($p \in M$) be given on M . Then $V_p = \{X_p \in T_p M \mid \omega_p(X_p) = 0\} \subset T_p M$ is a linear subspace of codimension 1. Is there a foliation of M in submanifolds $N \subset M$ so that

$$T_p N = V_p ? \quad (7.3)$$

If so, N is called an integral surface of V_p .

Theorem (Frobenius). Let ω be a 1-form. The following properties are equivalent:

- i) $\omega \wedge d\omega = 0$.
- ii) for any vector fields X, Y one has the implication: $\omega(X) = \omega(Y) = 0 \Rightarrow \omega([X, Y]) = 0$.
- iii) ω is locally of the form

$$\omega = \lambda df$$

with $\lambda, f \in \mathcal{F}$.

Remarks. 1) Let $\omega_p \neq 0$. Then (iii) implies that the level sets $N = \{p \in M \mid f(p) = \text{const}\}$ satisfy Eq. (7.3). Conversely, if there is a foliation in integral surfaces N , then $\omega(X) = \omega(Y) = 0$ means that X, Y are vector fields in N . Hence $[X, Y]$ are too, and (ii) holds true.

2) The theorem can be generalized to integral surfaces of lower dimension.

3) The theorem does not rely on a metric. The factorization in (iii) is not unique.

Remark. Let a metric g with Killing field K be given, and $\omega = \widehat{K}$. Then λ in (iii) can be chosen as $\lambda = (K, K)$:

$$\widehat{K} = (K, K)df, \quad (7.4)$$

where $Kf = 1$.

The converse of (7.2) now follows by choosing N as a level set of f , e.g. $f = 0$ in the construction on p. 66. The flow φ_t then maps N to the level set $f = t$, whence $f_{,i} = 0$ ($i = 1, 2, 3$). Thus

$$g_{0i} = \left(K, \frac{\partial}{\partial x^i}\right) = K_i = (K, K)f_{,i} = 0.$$

Proofs. One may assume that $\omega_p \neq 0$. We show (i) \Leftrightarrow (ii) in that both are equivalent to

$$d\omega = \omega \wedge \theta \quad (7.5)$$

for some 1-form θ . Let $e^1 = \omega, e^2, \dots, e^n$ be a local basis of 1-forms and $d\omega = \omega_{ij}e^i \wedge e^j$ (sum over $i < j$).

i) Clearly (7.5) implies (i). Conversely, if the expression

$$\omega \wedge d\omega = \omega_{ij}e^i \wedge e^j \wedge e^k$$

vanishes, then $\omega_{ij} = 0$ for $1 < i < j$. Thus $d\omega = \omega_{ij}e^i \wedge e^j = \omega \wedge \theta$ for $\theta = \omega_{ij}e^j$.

ii) By (1.28)

$$d\omega(X, Y) = X\omega(Y) - Y\omega(X) - \omega([X, Y]). \quad (7.6)$$

Given $\omega(X) = \omega(Y) = 0$ the conditions $d\omega(X, Y) = 0$ and $\omega([X, Y]) = 0$ become equivalent. Since in $d\omega(X, Y) = \omega_{ij}(X^i Y^j - X^j Y^i)$ the components $X^i = e^i(X), Y^i$ can be chosen at will up to $X^1 = Y^1 = 0$, we again conclude $\omega_{ij} = 0$ for $1 < i < j$.

The implication (iii) \Rightarrow (i) is immediate from $d\omega = d\lambda \wedge df$. As (i) \Rightarrow (iii) is concerned, we prove only the special case of the remark and maintain that

$$d\widehat{K}(X, K) = X(K, K) = d\lambda(X) , \quad (7.7)$$

where $\lambda = (K, K)$. Indeed, we have

$$0 = (L_K g)(X, K) = K(X, K) - ([K, X], K) - (X, \underbrace{[K, K]}_{=0}) ,$$

and then by (7.6) with $\omega = \widehat{K}$

$$\begin{aligned} d\widehat{K}(X, K) &= X\widehat{K}(K) - K\widehat{K}(X) - \widehat{K}([X, K]) \\ &= X(K, K) - \underbrace{K(K, X) - (K, [X, K])}_{=0} , \end{aligned}$$

proving (7.7). By (i)

$$\begin{aligned} 0 &= (\widehat{K} \wedge d\widehat{K})(K, X, Y) \\ &= \widehat{K}(K)d\widehat{K}(X, Y) + \widehat{K}(X)d\widehat{K}(Y, K) + \widehat{K}(Y)d\widehat{K}(K, X) \\ &= \lambda d\widehat{K}(X, Y) + \widehat{K}(X)d\lambda(Y) - \widehat{K}(Y)d\lambda(X) \end{aligned}$$

i.e. $\lambda d\widehat{K} + \widehat{K} \wedge d\lambda = 0$, and hence

$$d(\lambda^{-1}\widehat{K}) = \lambda^{-2}(\lambda d\widehat{K} - d\lambda \wedge \widehat{K}) = 0 .$$

By the Poincaré lemma (see p. 13) we have $\lambda^{-1}\widehat{K} = df$. That implies (7.4) and then $(K, K) = \widehat{K}(K) = (K, K)Kf$, whence $Kf = 1$. \square

7.2. The Schwarzschild metric

Ansatz: Static metric of the form

$$ds^2 = e^{2a} dt^2 - [e^{2b} dr^2 + r^2 (d\theta^2 + \sin^2 \theta d\varphi^2)] \quad (7.8)$$

on $\mathbb{R} \times \mathbb{R}_+ \times S^2$ with coordinates $t \in \mathbb{R}$, $r \in \mathbb{R}_+$, (θ, φ) polar coordinates on S^2 . Here $a = a(r)$, $b = b(r)$ are unknown functions, which are to be determined by the field equations (5.12) in vacuum.

Remarks: 1) The metric (7.8) is invariant under rotations of S^2 . Without proof: It is the most general static metric which is spherically symmetric: By this we mean that $R \in \text{SO}(3) : M \ni p \mapsto R(p) \in M$ acts on spacetime M as an isometry, i.e. $R^*g = g$, and that for each $p \in M$ the orbit $\{R(p) \mid R \in \text{SO}(3)\} \subset M$ is a spacelike 2-dimensional surface. The coordinate r in (7.8) is then chosen in such a way that the surface area is $4\pi r^2$.

2) The coordinate transformation $t \mapsto \tilde{t} = e^{-ct}$ (r, θ, φ fixed) corresponds to the replacement

$$a \mapsto \tilde{a} = a + c \quad (7.9)$$

in (7.8): a and \tilde{a} describe the same spacetime.

The Ricci tensor $R_{\mu\nu}$ can be computed by means of (a) the Cartan calculus or (b) the above chart.

a) Basis of 1-forms:

$$\left. \begin{array}{l} e^0 = e^a dt \\ e^1 = e^b dr \\ e^2 = r d\theta \\ e^3 = r \sin \theta d\varphi \end{array} \right\} g = g_{\mu\nu} e^\mu \otimes e^\nu, \quad g_{\mu\nu} = \begin{pmatrix} 1 & & & \\ & -1 & & \\ & & -1 & \\ 0 & & & -1 \end{pmatrix}. \quad (7.10)$$

(e^2, e^3 are equivalent in view of the spherical symmetry). We have

$$\begin{aligned} de^1 &= 0 \\ de^0 &= a' e^a dr \wedge dt = e^1 \wedge (a' e^{a-b} dt) \\ de^2 &= dr \wedge d\theta = e^1 \wedge (e^{-b} d\theta) \\ de^3 &= \sin \theta dr \wedge d\varphi + r \cos \theta d\theta \wedge d\varphi \\ &= e^1 \wedge (e^{-b} \sin \theta d\varphi) + e^2 \wedge (\cos \theta d\varphi) \end{aligned}$$

The structure equations (3.20, 3.21) for the connection 1-forms $\omega^\mu{}_\nu$ are:

$$\begin{aligned} \omega_{\mu\nu} + \omega_{\nu\mu} &= dg_{\mu\nu} = 0, \\ de^\mu &= e^\nu \wedge \omega^\mu{}_\nu. \end{aligned}$$

Solution: The only non-vanishing $\omega^\mu{}_\nu \neq 0$ are

$$\begin{aligned} -\omega^2{}_3 &= \omega^3{}_2 = \cos \theta d\varphi, \\ -\omega^1{}_3 &= \omega^3{}_1 = e^{-b} \sin \theta d\varphi, \\ -\omega^1{}_2 &= \omega^2{}_1 = e^{-b} d\theta, \\ \omega^1{}_0 &= \omega^0{}_1 = a' e^{a-b} dt. \end{aligned}$$

Curvature 2-forms: $\Omega^\mu{}_\nu = d\omega^\mu{}_\nu + \omega^\mu{}_\sigma \wedge \omega^\sigma{}_\nu$.

Result: ($i = 2, 3$), $\neq 0$ are

$$\begin{aligned} \Omega^0{}_1 &= \Omega^1{}_0 = (a'b' - a'' - a'^2) e^{-2b} e^0 \wedge e^1, \\ \Omega^0{}_i &= \Omega^i{}_0 = -\frac{a'}{r} e^{-2b} e^0 \wedge e^i, \\ -\Omega^1{}_i &= \Omega^i{}_1 = -\frac{b'}{r} e^{-2b} e^1 \wedge e^i, \\ -\Omega^2{}_3 &= \Omega^3{}_2 = -\frac{1}{r^2} (1 - e^{-2b}) e^2 \wedge e^3. \end{aligned}$$

Computation:

$$\begin{aligned} \Omega^1{}_0 &= d\omega^1{}_0 = (a'(a' - b') + a'') e^{a-b} dr \wedge dt, \\ \Omega^2{}_0 &= \omega^2{}_1 \wedge \omega^1{}_0 = a' e^{a-2b} d\theta \wedge dt, \\ \Omega^2{}_1 &= d\omega^2{}_1 = -b' e^{-b} dr \wedge d\theta, \\ \Omega^3{}_2 &= d\omega^3{}_2 + \omega^3{}_1 \wedge \omega^1{}_2 = -\sin \theta (1 - e^{-2b}) d\theta \wedge d\varphi. \end{aligned}$$

Ricci tensor:

$$R_{\mu\nu} = R^\alpha{}_{\mu\alpha\nu} = \Omega^\alpha{}_\mu(e_\alpha, e_\nu)$$

is diagonal because of $\Omega^\alpha{}_\mu \sim e^\alpha \wedge e^\mu$. One finds

$$\begin{aligned} R_{00} &= -(a'b' - a'' - a'^2)e^{-2b} + \frac{2a'}{r}e^{-2b}, \\ R_{11} &= (a'b' - a'' - a'^2)e^{-2b} + \frac{2b'}{r}e^{-2b}, \\ R_{22} = R_{33} &= -\frac{a'}{r}e^{-2b} + \frac{b'}{r}e^{-2b} + \frac{1}{r^2}(1 - e^{-2b}). \end{aligned}$$

b) The non-vanishing Christoffel symbols are ($' = d/dr$)

$$\begin{aligned} \Gamma^t{}_{tr} &= \Gamma^t{}_{rt} = a', \\ \Gamma^r{}_{tt} &= a'e^{2(a-b)}, \quad \Gamma^r{}_{rr} = b', \quad \Gamma^r{}_{\theta\theta} = -re^{-2b}, \quad \Gamma^r{}_{\varphi\varphi} = -r(\sin^2\theta)e^{-2b}, \\ \Gamma^\theta{}_{r\theta} &= \Gamma^\theta{}_{\theta r} = r^{-1}, \quad \Gamma^\theta{}_{\varphi\varphi} = -\sin\theta\cos\theta, \\ \Gamma^\varphi{}_{r\varphi} &= \Gamma^\varphi{}_{\varphi r} = r^{-1}, \quad \Gamma^\varphi{}_{\theta\varphi} = \Gamma^\varphi{}_{\varphi\theta} = \cot\theta. \end{aligned}$$

The Ricci tensor is diagonal and

$$\begin{aligned} R_{tt} &= -(a'b' - a'' - a'^2)e^{2(a-b)} + \frac{2a'}{r}e^{2(a-b)}, \\ R_{rr} &= (a'b' - a'' - a'^2) + \frac{2b'}{r}, \\ R_{\theta\theta} &= r(b' - a')e^{-2b} + 1 - e^{-2b}, \\ R_{\varphi\varphi} &= (\sin^2\theta)R_{\theta\theta}. \end{aligned} \tag{7.11}$$

Field equations (5.12) in vacuum:

$$R_{\mu\nu} = 0.$$

From (a) $R_{00} + R_{11} = 0$ or (b) $R_{tt}e^{-2(a-b)} + R_{rr} = 0$ it follows that $a' + b' = 0$, and by using the freedom (7.9):

$$a + b = 0.$$

From (a) $R_{22} = R_{33} = 0$ or (b) $R_{\theta\theta} = R_{\varphi\varphi} = 0$ it then follows that

$$\begin{aligned} 1 &= e^{-2b} - 2rb'e^{-2b} = (re^{-2b})' \\ re^{-2b} &= r - 2m, \quad (m : \text{integration constant}), \\ e^{2a} &= e^{-2b} = 1 - \frac{2m}{r}. \end{aligned} \tag{7.12}$$

Thereby also the last remaining equation (a) $R_{00} = 0$, resp. (b) $R_{rr} = 0$ is satisfied: it reads

$$((2b'^2 - b'')r - 2b')e^{-2b} = 0$$

and follows by differentiation of (7.12).

Schwarzschild metric:

$$ds^2 = \left(1 - \frac{2m}{r}\right) dt^2 - \left(1 - \frac{2m}{r}\right)^{-1} dr^2 - r^2 (d\theta^2 + \sin^2 \theta d\varphi^2) . \quad (7.13)$$

For $r \rightarrow \infty$ (7.13) is asymptotic to the flat metric of SR. It describes the gravitational field outside of a spherically symmetric mass distribution. Meaning of m : By (4.18) the Newtonian potential for $r \rightarrow \infty$ is

$$\varphi = \frac{c^2}{2}(g_{00} - 1) = -\frac{mc^2}{r} = -\frac{G_0 M}{r}$$

for a central body of mass M . The constant m turns out to be

$$m = \frac{G_0 M}{c^2} (> 0) .$$

At the Schwarzschild radius $r = 2m$ the metric (7.13) is singular in the coordinates employed: as $r \rightarrow 2m$ the opening angle of the light cones tends to zero. The region of spacetime described by (7.13) is shown in the figure. We shall see that at $r = 2m$ only the chart fails, without the metric becoming singular: there is a chart in which spacetime has an extension.

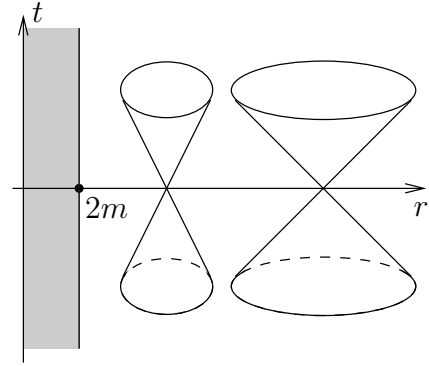

7.3. Geodesics in the Schwarzschild metric

Geodesics are orbits determined by the Lagrangian $\mathcal{L} = (\dot{x}, \dot{x})$, cf. (3.8),

$$\mathcal{L} = \left(1 - \frac{2m}{r}\right) \dot{t}^2 - \left(1 - \frac{2m}{r}\right)^{-1} \dot{r}^2 - r^2 (\dot{\theta}^2 + (\sin^2 \theta) \dot{\varphi}^2)$$

($\cdot = d/d\tau$, τ : affine parameter; $c = 1$). The equation for θ

$$-(r^2 \dot{\theta})' + (r \dot{\varphi})^2 \sin \theta \cos \theta = 0$$

is identically satisfied by $\theta = \pi/2$, a value which we will now assume (orbit in the equatorial plane). Then

$$\mathcal{L} = \left(1 - \frac{2m}{r}\right) \dot{t}^2 - \left(1 - \frac{2m}{r}\right)^{-1} \dot{r}^2 - (r \dot{\varphi})^2 .$$

The variables t, φ are cyclic. The corresponding **conservation laws** are

$$\begin{aligned} r^2 \dot{\varphi} &= l , & (\text{angular momentum}) \\ \left(1 - \frac{2m}{r}\right) \dot{t} &= \mathcal{E} . \end{aligned} \quad (7.14)$$

Moreover \mathcal{L} itself is conserved. That implies the **radial equation**

$$\mathcal{L} = \left(1 - \frac{2m}{r}\right)^{-1} (\mathcal{E}^2 - \dot{r}^2) - \frac{l^2}{r^2} ;$$

i.e.

$$\begin{aligned} \dot{r}^2 + V(r) &= \mathcal{E}^2 , \\ V(r) &= \left(1 - \frac{2m}{r}\right) \left(\mathcal{L} + \frac{l^2}{r^2}\right) . \end{aligned} \quad (7.15)$$

It is convenient to use the variable $u = 1/r$. From $\dot{u} = -u^2\dot{r}$ and $\dot{\varphi} = lu^2$ we have for $u' = du/d\varphi$

$$u'^2 = \left(\frac{\dot{u}}{\dot{\varphi}}\right)^2 = \frac{\mathcal{E}^2 - V}{l^2} = \frac{\mathcal{E}^2}{l^2} - (1 - 2mu) \left(\frac{\mathcal{L}}{l^2} + u^2\right) ,$$

which after deriving in φ (and dividing by $2u'$) becomes

$$u'' + u - \mathcal{L} \frac{m}{l^2} = 3mu^2 . \quad (7.16)$$

i) Perihelion advance

We consider **timelike** geodesics (4.7, 4.8) (free falling bodies) and normalize

$$\mathcal{L} = 1 , \quad \text{i.e. } \tau = \text{proper time} .$$

Then (7.16) reads

$$u'' + u - \frac{m}{l^2} = 3mu^2 . \quad (7.17)$$

Comparison with the **non-relativistic** equation for the radial motion (see Classical Mechanics)

$$\dot{r}^2 - \frac{2m}{r} + \frac{l^2}{r^2} = 2E ,$$

resp.

$$u'' + u - \frac{m}{l^2} = 0 , \quad (7.18)$$

shows that (given the identification $\mathcal{E}^2 - 1 = 2E$) the term $\sim r^{-3}$ in (7.15), resp. $\sim u^2$ in (7.17), describes the correction due to GR. Any (non-relativistic) solution of (7.18),

$$u_0 = \frac{1}{d}(1 + \varepsilon \cos \varphi) , \quad d = \frac{l^2}{m}$$

with $0 < \varepsilon < 1$ represents an **ellipse**: The azimuth has been chosen so that the perihelion is at $\varphi = 0, 2\pi, \dots$. We write the solution of (7.17) as $u = u_0 + v$ and obtain (to 1st order in m) that the perturbation v solves the linear inhomogeneous equation

$$v'' + v = \frac{3m}{d^2}(1 + 2\varepsilon \cos \varphi + \varepsilon^2 \cos^2 \varphi) .$$

Given the initial conditions $v = v' = 0$ at $\varphi = 0$, the three equations

$$v'' + v = \begin{cases} A_1 \\ A_2 \cos \varphi \\ A_3 \cos^2 \varphi \end{cases} \quad (7.19)$$

have the solutions

$$v = \begin{cases} A_1(1 - \cos \varphi) \\ \frac{1}{2}A_2\varphi \sin \varphi \\ \frac{1}{3}A_3(2 - \cos \varphi - \cos^2 \varphi) \end{cases} .$$

Only the 2nd term is not periodic, because the frequency of the forcing $\cos \varphi$ matches that of the homogeneous equation (resonance). It is also the only one that yields a contribution to $u'(2\pi) = v'(2\pi)$; indeed

$$u'(2\pi) = A_2\pi = \frac{6\pi m \varepsilon}{d^2}.$$

Due to $u''(2\pi) = -\varepsilon/d$ (0th order) the perihelion advance (i.e. the shift of the zero of $u'(\varphi)$) is

$$\Delta\varphi = -\frac{u'(2\pi)}{u''(2\pi)} = \frac{6\pi m}{d} = \frac{6\pi m}{a(1-\varepsilon^2)},$$

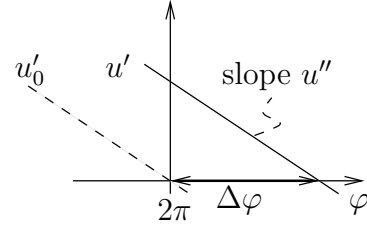

where a is the major semi-axis of the ellipse. For Mercury one obtains $\Delta\varphi \approx 43''$ per century ($'' = \text{arc seconds}$), which is observationally confirmed to about 1%. (Other perturbations are about 10 times larger!)

ii) Light deflection at the Sun

We consider **lightlike geodesics** (4.10): $\mathcal{L} = 0$. Then (7.16) reads

$$u'' + u = 3mu^2. \quad (7.20)$$

By contrast the equation $u'' + u = 0$ describes a straight light ray $u_0 = b^{-1} \sin \varphi$, i.e. $r \sin \varphi = b$ (choice of azimuth: perihelion at $\varphi = \pi/2$):

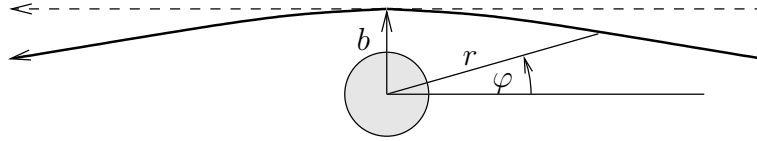

We solve (7.20) perturbatively by $u = u_0 + v$. The equation

$$v'' + v = \frac{3m}{b^2} \sin^2 \varphi$$

with $v = v' = 0$ at $\varphi = \pi/2$ correspond to the third case (7.19) under the replacement $\cos \varphi \rightsquigarrow \sin \varphi$ (including initial conditions). It has the solution

$$\begin{aligned} u &= \frac{1}{b} \sin \varphi + \frac{3m}{b^2} \frac{1}{3} (2 - \sin \varphi - \sin^2 \varphi) \\ &= \frac{\varphi}{b} + \frac{m}{b^2} (2 - \varphi) + O(\varphi^2), \quad (\varphi \rightarrow 0), \end{aligned}$$

i.e. the zero $\varphi = 0$ of u_0 is shifted to $\varphi_\infty = -2m/b$ in 1st order in m . The total deflection $\delta = 2|\varphi_\infty|$ amounts to

$$\delta = \frac{4m}{b} \approx \frac{1,75''}{b/R_\odot}$$

(R_\odot : Sun radius) and can be observed during a total solar eclipse:

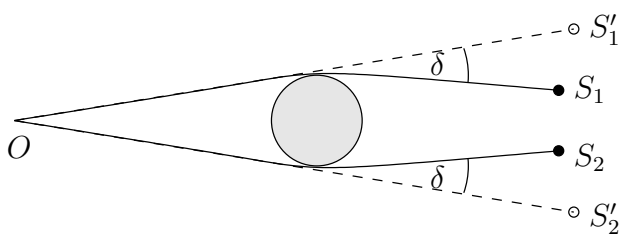

(O : observer; S, S' : true and apparent position of a star; $b \approx R_\odot$). The angle $\angle(S'_1, S'_2)$ is greater by 2δ than in absence of the Sun. The agreement with observation is about 1%. (Other effects: refraction in the solar corona.)

7.4. The Kruskal extension of the Schwarzschild metric: Black Hole

We discuss the (apparent) singularity of the metric at $r = 2m > 0$ in the chart (7.13). The scalar quantity (hence independent of the chart)

$$R_{\alpha\beta\gamma\delta}R^{\alpha\beta\gamma\delta} = \frac{48m^2}{r^2} \quad (7.21)$$

does not exhibit any singularity at $r = 2m$. A particle which falls radially ($l = 0$) has by (7.15)

$$\dot{r} = -(\mathcal{E}^2 - V(r))^{1/2}, \quad V(r) = 1 - \frac{2m}{r},$$

($\dot{} = d/d\tau$). The particle thus falls with increasing rate $|\dot{r}|$ towards the Schwarzschild radius $r = 2m$, where it arrives after finite proper time. The coordinate time however diverges. We have

$$\dot{t} = \mathcal{E}/V(r),$$

and thus

$$-\frac{dt}{dr} = -\frac{\dot{t}}{\dot{r}} = \frac{\mathcal{E}}{\left(1 - \frac{2m}{r}\right) \sqrt{\mathcal{E}^2 - \left(1 - \frac{2m}{r}\right)}} \approx \frac{1}{1 - \frac{2m}{r}} \rightarrow \infty$$

for $r \rightarrow 2m$. Setting $r = 2m + \rho$, we find

$$\frac{d\rho}{dt} = -\frac{\rho}{2m}$$

to 1st order in ρ . The orbit

$$r = 2m + \text{const } e^{-t/2m}$$

thus reaches $r = 2m$ only at $t = +\infty$. This and (7.21) are hints that the singularity at $r = 2m$ of the Schwarzschild metric only reflects a failure of the coordinate system — as it is confirmed by a change of coordinates:

Kruskal transformation

$$u = \left(\frac{r}{2m} - 1\right)^{1/2} e^{r/4m} \text{ch } \frac{t}{4m},$$

$$v = \left(\frac{r}{2m} - 1\right)^{1/2} e^{r/4m} \text{sh } \frac{t}{4m}.$$

This transformation $(t, r) \leftrightarrow (u, v)$ is to be supplemented by unchanged θ, φ . We then have

$$u^2 - v^2 = \left(\frac{r}{2m} - 1\right) e^{r/2m} =: g\left(\frac{r}{2m}\right), \quad (7.22)$$

$$v/u = \text{th } \frac{t}{4m}.$$

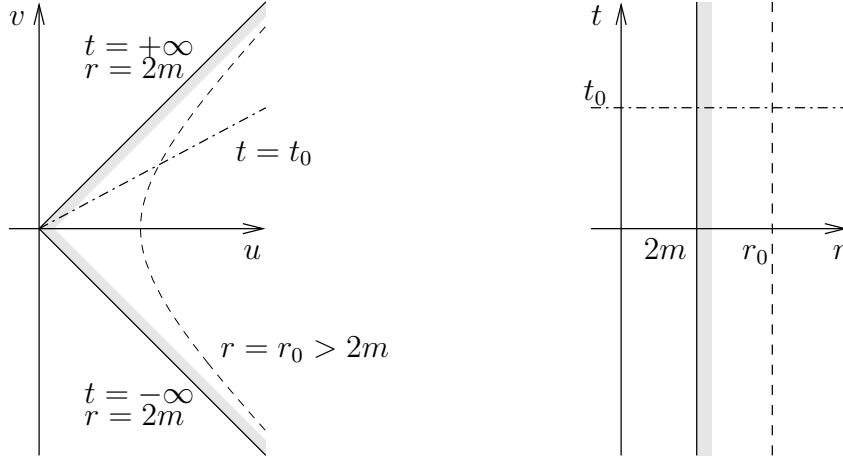

The chart domain $-\infty < t < +\infty$, $r > 2m$ is mapped onto the sector $u > |v|$ in the (u, v) -plane:

In the new coordinates the metric reads

$$ds^2 = \left(1 - \frac{2m}{r}\right) dt^2 - \left(1 - \frac{2m}{r}\right)^{-1} dr^2 = \frac{32m^3}{r} e^{-r/2m} (dv^2 - du^2) \quad (7.23)$$

(+ angular part: $-r^2(d\theta^2 + \sin^2\theta d\varphi^2)$). On the r.h.s. $r = r(u, v)$ is to be understood as the solution of (7.22).

Proof: We set $4m = 1$. By

$$\frac{d}{dr}(2r - 1)^{1/2} e^r = 2r(2r - 1)^{-1/2} e^r$$

we have

$$\begin{aligned} du &= 2r(2r - 1)^{-1/2} e^r \operatorname{ch} t \, dr + (2r - 1)^{1/2} e^r \operatorname{sh} t \, dt, \\ dv &= 2r(2r - 1)^{-1/2} e^r \operatorname{sh} t \, dr + (2r - 1)^{1/2} e^r \operatorname{ch} t \, dt, \\ dv^2 - du^2 &= (2r - 1)e^{2r} dt^2 - 4r^2(2r - 1)^{-1} e^{2r} dr^2 \\ &= 2re^{2r} \left[\left(1 - \frac{1}{2r}\right) dt^2 - \left(1 - \frac{1}{2r}\right)^{-1} dr^2 \right]. \end{aligned}$$

We now revert to $r \rightarrow r/4m$, $t \rightarrow t/4m$. □

The extension: The function $g(x)$, ($0 < x < \infty$) increases monotonically from -1 to $+\infty$, since

$$((x - 1)e^x)' = xe^x > 0.$$

Thus, $r(u, v)$ is uniquely determined by (7.22) in the region

$$v^2 - u^2 < 1. \quad (7.24)$$

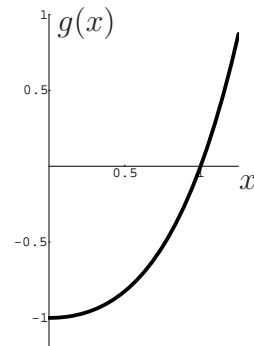

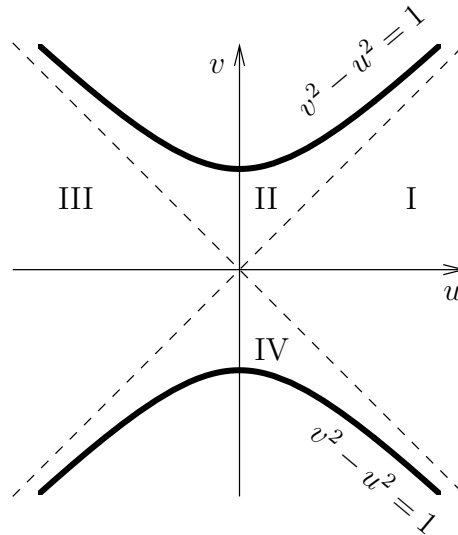

In the so extended (u, v) -chart we **define** the metric by (7.23). The field equations (5.12) remain satisfied, since (7.23) is real analytic for u, v as in (7.24). We partition the extended chart in 4 regions, I-IV:

I is the region of the original Schwarzschild metric. The regions III, IV result by reflection $(u, v) \mapsto (-u, -v)$ from I, II. We thus discuss region II only. There too we can introduce “Schwarzschild coordinates” t and $r < 2m$ by

$$u = \left(1 - \frac{r}{2m}\right)^{1/2} e^{r/4m} \operatorname{sh} \frac{t}{4m},$$

$$v = \left(1 - \frac{r}{2m}\right)^{1/2} e^{r/4m} \operatorname{ch} \frac{t}{4m}.$$

Because of

$$v^2 - u^2 = \left(1 - \frac{r}{2m}\right) e^{r/2m}, \quad u/v = \operatorname{th} \frac{t}{4m}$$

region II ($0 < v^2 - u^2 < 1, v > 0$) is mapped onto the strip $0 < r < 2m, -\infty < t < +\infty$, and the metric takes there the form (7.23). But: Because of $1 - (2m/r) < 0$, t has now become a spatial coordinate and r a temporal one! In the (u, v) -chart, where $ds^2 \sim du^2 - dv^2$, the light cones are given by lines at 45° ; in the (t, r) -chart, they are given by curves $dr/dt = \pm(1 - (2m/r))$,

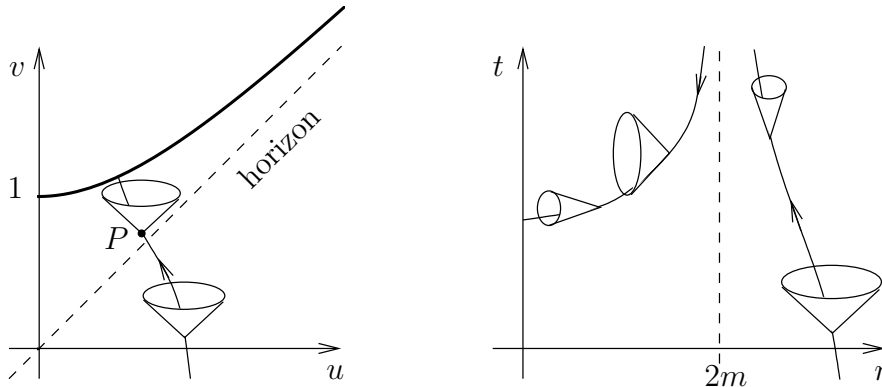

are positioned vertically for $r > 2m$ (resp. horizontally for $r < 2m$), and degenerate at $r = 2m$. The causal structure of this spacetime is manifest in the (u, v) -chart. Future

oriented time- or lightlike curves through an event P located beyond the horizon never reach this side: For an exterior observer the opposite portion II of spacetime remains hidden (**black hole**). Trajectories there actually end after finite proper time in the singularity $v^2 - u^2 = 1$, i.e. at $r = 0$. In contrast to $r = 2m$, this singularity is truly one of the manifold. For instance (7.21) is singular at $r = 0$. For reversed reasons, region IV is called a white hole.

We conclude the section with a result showing that the ansatz (7.8) can be relaxed.

Theorem (Birkhoff). Any spherically symmetric solution g of the field equations in vacuum (g does not need to be assumed static) is locally isometric to a part of the Schwarzschild-Kruskal spacetime.

Remark. This is in analogy with Newtonian gravitation: The potential in the exterior of a spherically symmetric, possibly time-dependent mass distribution is given by $\varphi = -G_0M/r$ and is hence static, since the total mass M is conserved.

Sketch of proof. The metric is of the form (7.8), though with $a = a(t, r)$, $b = b(t, r)$. The transformations which preserve the ansatz (cf. Remark 2 on p. 68), get generalized to $t \mapsto \tilde{t} = \int^t e^{-c(s)} ds$, which is tantamount to replacing (7.9) by $c = c(t)$. A computation, which parallels that of the static case, yields the non-vanishing components of the Ricci tensor

$$\begin{aligned} R_{tt} &= R_{tt}^{(0)} - f, & R_{rr} &= R_{rr}^{(0)} + e^{2(b-a)} f, \\ R_{\theta\theta} &= R_{\theta\theta}^{(0)} + e^{2(b-a)} f, & R_{\varphi\varphi} &= (\sin^2 \theta) R_{\theta\theta}, \\ R_{tr} &= R_{rt} = \frac{2\dot{b}}{r}, \end{aligned}$$

where (0) stands for the static quantities (7.11) and $f = \dot{b}^2 - \dot{a}\dot{b} + \ddot{b}$. This time the field equations yield $b = b(r)$, whence $f = 0$, and still $a' + b' = 0$. Together with the aforementioned replacement (7.9) this again yields $a + b = 0$. Hence the Schwarzschild metric (7.13) results again. \square

Application: Spherically symmetric collapse of a star. Exterior spacetime.

The radius of very massive stars can become $< 2m$. Region II of the Kruskal metric then becomes relevant. A horizon appears at $r = 2m$ outside of the star and its collapse into the singularity is now unavoidable, since the worldlines of particles on its surface are timelike.

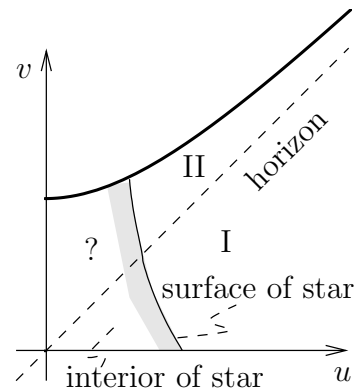

Remark. Complementary to the above proposition is the following **Theorem** (Israel): Any static black hole (g does not need to be assumed spherically symmetric) is given by the Schwarzschild metric.

7.5. The Kerr metric and rotating black holes

The exterior of a rotating black hole or (steady) star is described by a stationary metric, rather than by a static one.

Coordinates (Boyer-Lindquist): $t \in \mathbb{R}$, $r > 0$, θ , φ spherical coordinates

Parameters: m , a

Notations:

$$\begin{aligned}\Delta &= r^2 - 2mr + a^2 \\ \rho^2 &= r^2 + a^2 \cos^2 \theta \\ \Sigma^2 &= (r^2 + a^2)^2 - a^2 \Delta \sin^2 \theta\end{aligned}$$

Identity:

$$\rho^4 \Delta - 4m^2 r^2 a^2 \sin^2 \theta = \Sigma^2 (\rho^2 - 2mr) \quad (7.25)$$

Metric (Kerr 1963)

$$ds^2 = \left(1 - \frac{2mr}{\rho^2}\right) dt^2 + 4 \frac{mar}{\rho^2} \sin^2 \theta d\varphi dt - \frac{\Sigma^2}{\rho^2} \sin^2 \theta d\varphi^2 - \frac{\rho^2}{\Delta} dr^2 - \rho^2 d\theta^2 \quad (7.26)$$

Alternate expression: completing the square in $d\varphi$ gives

$$ds^2 = \frac{\rho^2}{\Sigma^2} \Delta dt^2 - \frac{\Sigma^2}{\rho^2} \sin^2 \theta (d\varphi - \Omega dt)^2 - \frac{\rho^2}{\Delta} dr^2 - \rho^2 d\theta^2 \quad (7.27)$$

with

$$\Omega = a \cdot \frac{2mr}{\Sigma^2}.$$

Indeed, that expression yields the same $g_{\varphi\varphi}, g_{\varphi t}$ as in (7.26) and, by (7.25),

$$g_{tt} = \frac{\rho^2}{\Sigma^2} \Delta - \frac{\Sigma^2}{\rho^2} \sin^2 \theta \cdot \Omega^2 = \frac{1}{\rho^2 \Sigma^2} (\rho^4 \Delta - 4m^2 r^2 a^2 \sin^2 \theta) = 1 - \frac{2mr}{\rho^2}.$$

Remarks. 1) The special case $a = 0$ is the Schwarzschild metric (7.13), because $\rho^2 = r^2$, $\Sigma^2 = r^4$.

2) The Kerr metric solves the vacuum equation $R_{\mu\nu} = 0$. It is the most general stationary solution which is axisymmetric: A space-time on which $\text{SO}(2)$ acts as isometries under which each orbit is a closed space-like curve.

3) Any just axisymmetric solution is given by Kerr or some extension thereof (cf. Birkhoff's thm.). Any stationary black hole is given by Kerr (cf. Israel's thm.). This is known as the "**no hair**" **theorem**: Black holes have no property other than m , a (or charge, if an electromagnetic field, rather than vacuum, is allowed outside).

4) The metric (7.26) tends to Minkowski in polar coordinates at $r \rightarrow \infty$.

5) Meaning of parameters: m mass (from Newtonian limit $r \rightarrow \infty$); $J = am$ angular momentum (without proof).

The metric has a singularity at $\Delta = 0$, i.e., at

$$r = r_{\pm} = m \pm \sqrt{m^2 - a^2} .$$

It exists (and with it the black hole) only for $|a| \leq m$ (and hence $|J| \leq m^2$). We restrict to $r > r_+$.

The metric has the Killing fields $\Phi = \partial/\partial\varphi$, $K = \partial/\partial t$:

- Φ is space-like:

$$g(\Phi, \Phi) = g_{\varphi\varphi} < 0 .$$

- K is time-like,

$$g(K, K) = g_{tt} = \frac{1}{\rho^2}(r^2 + a^2 \cos^2 \theta - 2mr) > 0 ,$$

for

$$r > r_0(\theta) = m + \sqrt{m^2 - a^2 \cos^2 \theta} \quad (\geq r_+) .$$

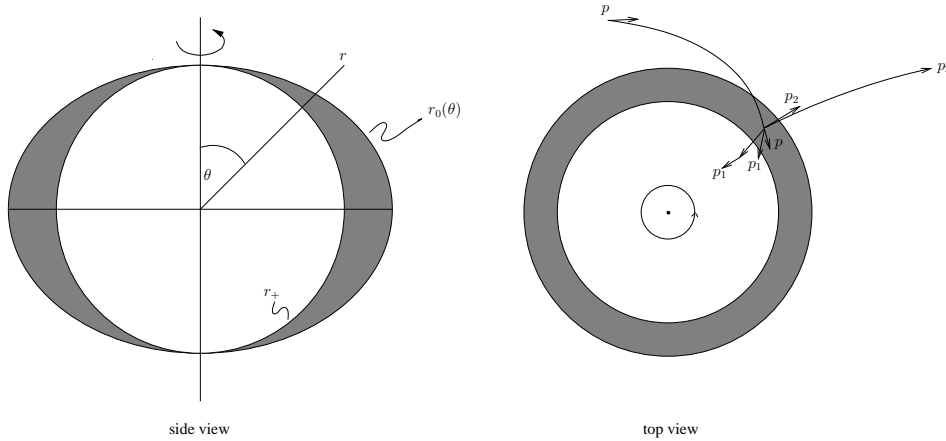

Figure 1: See page 80 for trajectories

The shaded region $r_+ < r < r_0(\theta)$ is the **ergosphere**. Its physical meaning will emerge from considering various observers. As such, their 4-velocity $u^\mu = (\dot{t}, \dot{r}, \dot{\theta}, \dot{\varphi})$ is time-like, $(u, u) = +1$.

i) A **static** observer has fixed coordinates r, θ, φ : $u^\mu = (\dot{t}, 0, 0, 0) \propto K$. It can exist for $r > r_0(\theta)$. For $r < r_0(\theta)$ any observer is dragged w.r.t. infinity.

ii) A **stationary** observer has fixed r, θ , and $\omega \equiv d\varphi/dt = \dot{\varphi}/\dot{t}$. It has $u^\mu = (\dot{t}, 0, 0, \omega\dot{t}) \propto (1, 0, 0, \omega)$ and, see (7.27),

$$(u, u) \propto \frac{\rho^2}{\Sigma^2} \Delta - \frac{\Sigma^2}{\rho^2} \sin^2 \theta (\omega - \Omega)^2 ;$$

u^μ is time-like if

$$|\omega - \Omega| < \frac{\rho^2}{\Sigma^2} \cdot \frac{\Delta^{1/2}}{\sin \theta} .$$

The bound on the r.h.s. is $< \Omega$ iff $r < r_0(\theta)$, since that is when $\omega = 0$ is not contained in the interval, see (i).

iii) Observer **freely falling** from infinity. Note: V Killing field, $x(\tau)$ geodesic. Then (V, \dot{x}) is constant in τ by Noether's theorem. Indeed, $\mathcal{L} = \frac{1}{2}\dot{x}_\alpha\dot{x}^\alpha$ has constant $V_\alpha \cdot \frac{\partial \mathcal{L}}{\partial \dot{x}^\alpha} = V^\alpha \dot{x}_\alpha$.

Take $V = \Phi$ and $u = \dot{x}$. At infinity, $(\Phi, u) = 0$; at a finite position along the geodesic

$$0 = (\Phi, u) = -\frac{\Sigma^2}{\rho^2} \sin^2 \theta (\dot{\varphi} - \Omega \dot{t}) :$$

the freely falling observer rotates with angular velocity

$$\frac{d\varphi}{dt} = \frac{\dot{\varphi}}{\dot{t}} = \Omega = a \cdot \frac{2mr}{\Sigma^2} ,$$

being dragged by the rotating mass inside.

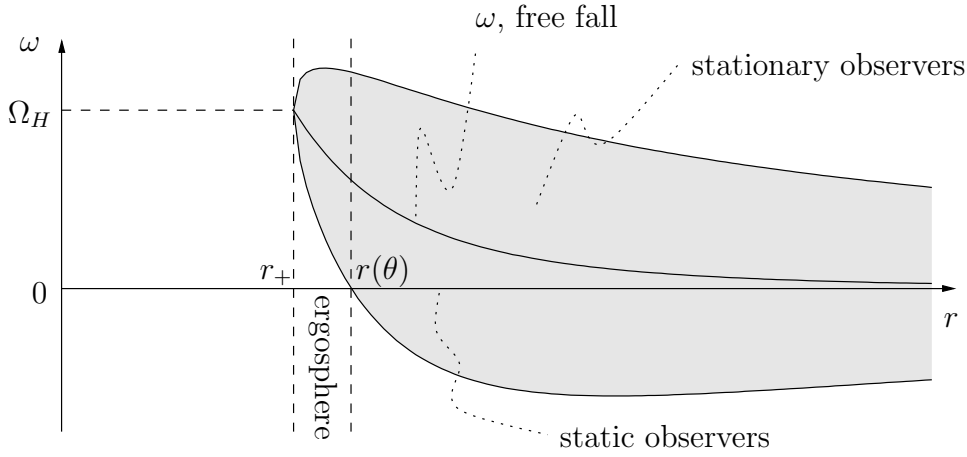

The angular velocity at $r = r_+$,

$$\Omega_H = \Omega|_{r_+} = a \cdot \frac{2mr}{\Sigma^2} \Big|_{r_+} = \frac{a}{2mr_+} ,$$

(use $\Sigma|_{r_+} = r_+^2 + a^2 = 2mr_+$), is the **angular velocity of the black hole**.

Energy extraction (Penrose 1969). A freely falling particle of 4-momentum $p = m\dot{x}$ has conserved “energy” $E = (K, p)$ (take $V = K$ above). Wherever K is time-like, $E > 0$. In particular, for an observer resting near infinity, where the metric is $\sim \eta_{\mu\nu}$ and t is its time, $E = p^t$ is indeed the energy. Let the particle decay,

$$p = p_1 + p_2 ,$$

inside the ergosphere (s. fig. on p. 79), after which free fall carries particle 1 across the horizon $r = r_+$ inside the black hole and particle 2 back to infinity. While $E_2 = (K, p_2) > 0$ as explained, one may have $E_1 = (K, p_1) < 0$, because K is space-like along the fall of 1. Hence

$$E = E_1 + E_2 < E_2 :$$

energy has been extracted from the black hole! However, particle 1 reduces the angular momentum of the black hole, whereby the ergosphere decreases and the process can not be repeated indefinitely.

7.6. Hawking radiation

Energy emission is possible even from a static black hole, provided quantum effects are taken into account. Suppose a pair of particles is created from nothing,

$$0 = p_1 + p_2 .$$

Then

$$0 = \langle K, p_1 \rangle + \langle K, p_2 \rangle \equiv E_1 + E_2$$

with $K = \partial/\partial t$ and E_1, E_2 conserved from then on. They cannot be created outside of the horizon, since then $E_1, E_2 > 0$ as explained at the end of the previous section. If they are created inside, E_1, E_2 may have opposite signs, but the particles never get outside. A vacuum fluctuation, however, may create a pair with particle 1 inside and 2 outside of the horizon. As particle 2 reaches a distant observer with energy $E_2 > 0$ it is part, with many others, of the **Hawking radiation**. A detailed discussion requires Quantum Field Theory on a curved spacetime.

a) Classical Klein-Gordon field. The action for a scalar field of mass μ is

$$S = \int d^4x \sqrt{|g|} \cdot \underbrace{\frac{1}{2}(\partial_\mu \varphi \partial^\mu \varphi - \mu^2 \varphi^2)}_{\mathcal{L}} ,$$

where $\partial^\mu \varphi = g^{\mu\nu} \partial_\nu \varphi$. It is invariant under coordinate transformations $x \mapsto \tilde{x}$, with φ transforming as a scalar, $\varphi(x) = \tilde{\varphi}(\tilde{x})$. The equation of motion,

$$\partial_\nu \frac{\partial(\sqrt{|g|}\mathcal{L})}{\partial(\partial_\nu \varphi)} - \frac{\partial(\sqrt{|g|}\mathcal{L})}{\partial \varphi} = 0 , \quad (7.28)$$

is

$$\partial_\nu (\sqrt{|g|} g^{\mu\nu} \partial_\mu \varphi) + \mu^2 \sqrt{|g|} \varphi = 0 , \quad (7.29)$$

i.e.

$$(\square_g + \mu^2)\varphi = 0 , \quad (7.30)$$

where $\square_g = |g|^{-1/2} \partial_\nu (|g|^{1/2} g^{\mu\nu} \partial_\mu)$ is the Laplacian for the metric g . Canonical quantization rests on equal time commutators. This requires a foliation of spacetime in space-like 3-surfaces Σ , which without loss may be taken as surfaces of constant x^0 . The conjugate momentum is

$$\pi(x) = \sqrt{|g|} g^{\mu 0} \partial_\mu \varphi(x)$$

and the Hamiltonian is

$$H = \int_{x^0=0} d^3x (\pi \partial_0 \varphi - \sqrt{|g|} \mathcal{L}) = \int_{x^0=0} d^3x \sqrt{|g|} (g^{\mu 0} \partial_\mu \varphi \partial_0 \varphi - \mathcal{L}) .$$

The initial data $\varphi(\underline{x}) = \varphi(x)|_{x^0=0}$, $\pi(\underline{x}) = \pi(x)|_{x^0=0}$ make up the phase space

$$\Gamma = \{(\varphi(\underline{x}), \pi(\underline{x}))_{\underline{x} \in \mathbb{R}^3}\}$$

with Poisson brackets

$$\{\pi(\underline{x}), \varphi(\underline{y})\} = \delta^{(3)}(\underline{x} - \underline{y}) , \quad \{\varphi(\underline{x}), \varphi(\underline{y})\} = 0 , \quad \{\pi(\underline{x}), \pi(\underline{y})\} = 0 .$$

They determine the solution through the canonical equations of motion

$$\frac{\partial \varphi}{\partial t}(t, \underline{x}) = \{H, \varphi(t, \underline{x})\}, \quad \frac{\partial \pi}{\partial t}(t, \underline{x}) = \{H, \pi(t, \underline{x})\},$$

which, as usual, are equivalent to (7.28) or (7.30).

Let f, h be any complex solutions of (7.30) and let

$$j^\mu = \text{i}g^{\mu\nu}(\bar{f}\partial_\nu h - (\partial_\nu \bar{f})h).$$

Then, see (5.24),

$$j^\mu{}_{;\mu} \cdot \sqrt{|g|} = (\sqrt{|g|}j^\mu)_{;\mu} = 0$$

by the equation of motion (7.29). As a result,

$$\begin{aligned} \langle f, h \rangle &:= \int_\Sigma i_j \eta \\ &= \int_\Sigma \sqrt{|g|} j^\mu d\sigma_\mu = \int_{x^0=t} d^3x \sqrt{|g|} j^0, \end{aligned}$$

where i_j is the inner product (1.39) and $d\sigma_\mu$ the coordinate normal to Σ , is **independent** of the slice Σ , resp. of t . This follows by Gauss' theorem if j^μ decays fast enough in space-like directions. We denote the space of solutions equipped with the inner product $\langle f, h \rangle$ by \mathcal{K} . It satisfies

$$\overline{\langle f, h \rangle} = -\langle \bar{f}, \bar{h} \rangle = \langle h, f \rangle;$$

in particular

$$\langle f, \bar{f} \rangle = 0$$

and $\langle f, f \rangle$ is real. Note that it is not positive definite, since $\langle f, f \rangle = -\langle \bar{f}, \bar{f} \rangle$; however it is nondegenerate ($\langle f, h \rangle = 0, (h \in \mathcal{K}) \Rightarrow f = 0$), as seen from

$$\langle f, h \rangle = \text{i} \int_{x^0=0} d^3x (\bar{f}(\sqrt{|g|}g^{0\nu}\partial_\nu h) - (\sqrt{|g|}g^{0\nu}\partial_\nu \bar{f})h),$$

where $h(\underline{x})$ and the corresponding momentum $\sqrt{|g|}g^{0\nu}(\partial_\nu h)(\underline{x})$ may be chosen at will.

Taking for h the field itself, we define functions on Γ by

$$a(f) := \langle f, \varphi \rangle = \text{i} \int_{x^0=0} d^3x (\bar{f}(\underline{x})\pi(\underline{x}) - (\sqrt{|g|}g^{0\nu}\partial_\nu \bar{f})(\underline{x})\varphi(\underline{x})). \quad (7.31)$$

Since $f(\underline{x})$ and the corresponding momentum may be chosen arbitrarily, the complex data $a(f)$ determine the real data $\varphi(\underline{x}), \pi(\underline{x})$. However, they are not independent:

$$\overline{a(f)} = -a(\bar{f}). \quad (7.32)$$

Their Poisson bracket is

$$\{a(f), \overline{a(h)}\} = \text{i}\langle f, h \rangle, \quad (7.33)$$

which by (7.32) also implies

$$\{a(f), a(h)\} = -\text{i}\langle f, \bar{h} \rangle, \quad (7.34)$$

$$\{\overline{a(f)}, \overline{a(h)}\} = -\text{i}\langle \bar{f}, h \rangle. \quad (7.35)$$

b) Quantization. Canonical quantization of a Hamiltonian system is, at least in a first step, a map

$$\mathcal{F}(\Gamma) \rightarrow \mathcal{A} \quad (7.36)$$

from classical to quantum **observables**, i.e. from (complex) functions $a = a(q, p)$ on Γ into an algebra with involution $*$ (technically a C^* -algebra), such that

$$a \mapsto A \Rightarrow \bar{a} \mapsto A^* .$$

Moreover for a distinguished set of canonical coordinates a, b, \dots we have ($\hbar = 1$)

$$\{a, b\} \mapsto i[A, B] .$$

States ω are linear maps $\omega : \mathcal{A} \rightarrow \mathbb{C}$, $A \mapsto \omega(A)$, where $\omega(A)$ has the meaning of the expectation value of the observable A in the state ω . They should satisfy

$$\omega(1) = 1 , \quad \omega(A^*A) \geq 0 . \quad (7.37)$$

In particular, we have the Cauchy-Schwarz inequality

$$|\omega(A^*B)|^2 \leq \omega(A^*A)\omega(B^*B) . \quad (7.38)$$

In a second step, a Hilbert space may be constructed and expectation values computed in the way known from bra-ket Quantum Mechanics. This is accomplished abstractly by the GNS construction:

Theorem (Gelfand, Naimark, Segal). Let ω be a state on \mathcal{A} . Then there are

- a Hilbert space \mathcal{H} ,
- a vector $\Omega \in \mathcal{H}$,
- a representation π of \mathcal{A} on \mathcal{H} ,

such that

$$\omega(A) = (\Omega, \pi(A)\Omega)$$

and $\{\pi(A)\Omega | A \in \mathcal{A}\}$ is dense in \mathcal{H} . For given ω , these objects are unique up to isomorphisms.

Of course, any normalized vector $\psi \in \mathcal{H}$ defines a state by $\omega_\psi(A) = (\psi, \pi(A)\psi)$, and so does any density matrix on \mathcal{H} . However the states so obtained from a given ω do not exhaust all states on \mathcal{A} . In this sense the algebra \mathcal{A} is more fundamental than a Hilbert space \mathcal{H} on which it is represented.

In the context of the Klein-Gordon equation we denote the same way both kinds of observables in (7.36) ($a(f) \mapsto a(f)$) and obtain from (7.32 - 7.35)

$$\begin{aligned} a^*(f) &= -a(\bar{f}) , \\ [a(f), a^*(h)] &= \langle f, h \rangle , \\ [a(f), a(h)] &= -\langle f, \bar{h} \rangle , \\ [a^*(f), a^*(h)] &= -\langle \bar{f}, h \rangle , \end{aligned} \quad (7.39)$$

(one could have stated these equations in terms of $\varphi(\underline{x})$, $\pi(\underline{x})$ instead.) The algebra \mathcal{A} is generated by $a(f)$, ($f \in \mathcal{K}$).

A particular class of states on \mathcal{A} (quasi-free states) is specified by (i)

$$\omega(a^*(f)a(h)) = \langle h, \rho f \rangle , \quad (7.40)$$

where ρ is a positive semidefinite operator on \mathcal{K} , cf. (7.37),

$$\langle f, \rho f \rangle \geq 0 , \quad (f \in \mathcal{K}) ,$$

and (ii) the use of Wick's lemma (sum over contractions) to compute expectations of any products of $a^*(f)$'s and $a(h)$'s. Eq. (7.39) implies

$$\rho + \bar{\rho} = -1 , \quad (7.41)$$

where $\bar{\rho} = C\rho C$ and $C : f \mapsto \bar{f}$ is the complex conjugation.

Examples of this kind may be constructed as follows. Let $\mathcal{H} \subset \mathcal{K}$ be a subspace such that

$$\mathcal{K} = \mathcal{H} \oplus \bar{\mathcal{H}}$$

with $\bar{\mathcal{H}} = C\mathcal{H}$, and

$$\langle f, f \rangle \geq 0 , \quad (f \in \mathcal{H}) , \quad (7.42)$$

$$\langle f, h \rangle = 0 , \quad (f \in \mathcal{H} , h \in \bar{\mathcal{H}}) . \quad (7.43)$$

Solutions $f \in \mathcal{H}$ (resp. $\bar{\mathcal{H}}$) may be seen abstractly as single **particle** (resp. **antiparticle**) states. Then

$$\rho = N \oplus (-1 - \bar{N}) \quad (7.44)$$

with $\langle f, Nf \rangle \geq 0$, ($f \in \mathcal{H}$) defines an operator with (7.37). Indeed, by the block form of (7.44) it suffices to verify that property for $f \in \mathcal{H}$ (which is the hypothesis) and for $f \in \bar{\mathcal{H}}$: Since (7.41) holds by construction,

$$\begin{aligned} \langle f, \rho f \rangle &= \overline{\langle f, \rho f \rangle} = -\langle \bar{f}, \bar{\rho} \bar{f} \rangle \\ &= \langle \bar{f}, (1 + \rho) \bar{f} \rangle = \langle \bar{f}, (1 + N) \bar{f} \rangle \geq 0 , \end{aligned}$$

because $\bar{f} \in \mathcal{H}$.

In the case $N = 0$ the GNS Hilbert space can be realized as the bosonic Fock space \mathcal{F} over \mathcal{H} : \mathcal{F} is the span of

$$a^*(f_1) \cdots a^*(f_n) \Omega , \quad (f_i \in \mathcal{H}) \quad (7.45)$$

with

$$a(f) \Omega = 0 , \quad (f \in \mathcal{H}) . \quad (7.46)$$

c) Quantization of the Klein-Gordon field in Minkowski space. Solutions $f \in \mathcal{K}$ of $(\square + \mu^2)f = 0$ are superpositions of positive and negative frequency states

$$e^{i(\vec{k} \cdot \vec{x} \mp \omega t)}$$

with $\omega = \omega(\vec{k}) = \sqrt{\vec{k}^2 + \mu^2}$. Let \mathcal{H} be the subspace of **positive** frequency solutions. Writing $f = f_+ \oplus f_-$ with $f_+ \in \mathcal{H}$, $f_- \in \overline{\mathcal{H}}$ one finds by the Parseval identity

$$\langle f, h \rangle = \int \frac{d^3k}{2\omega} (\overline{f_+(\vec{k})} h_+(\vec{k}) - \overline{f_-(\vec{k})} h_-(\vec{k})),$$

where $f_{\pm}(\vec{k})$ define the wave packets:

$$f_{\pm}(x) = (2\pi)^{-3/2} \int \frac{d^3k}{2\omega} f_{\pm}(\vec{k}) e^{i(\vec{k} \cdot \vec{x} \mp \omega t)}.$$

In particular, (7.42, 7.43) hold true.

This choice of \mathcal{H} is Lorentz invariant. Indeed $\vec{k} \cdot \vec{x} \mp \omega t = -k_{\mu} x^{\mu}$ with $k^{\mu} = (\pm\omega(\vec{k}), \vec{k})$ on the upper, resp. lower mass shell: those are invariant under orthochronous Lorentz transformations (time-reversal flips \mathcal{H} and $\overline{\mathcal{H}}$). Equivalently, along the worldline $x^{\mu}(\tau) = u^{\mu} \tau + b^{\mu}$, $((u, u) = 1)$ of an inertial observer the phase

$$e^{i(\vec{k} \cdot \vec{x} - \omega t)} = e^{-i(k_{\mu} b^{\mu})} e^{-i(k_{\mu} u^{\mu}) \tau}$$

remains of positive frequency because $k_{\mu} u^{\mu} = \omega u^0 - \vec{k} \cdot \vec{u} \geq \omega u^0 - |\vec{k}| |\vec{u}| > 0$. Quantization in QFT usually proceeds by defining the vacuum state through (7.44) with $N = 0$ on \mathcal{H} (Minkowski vacuum, again a manifestly Lorentz invariant choice); this produces the Fock space (7.45, 7.46). However one may also consider positive temperature states, specified in momentum space by $N = (e^{\beta\omega(\vec{k})} - 1)^{-1}$, i.e.,

$$\omega(a^*(f)a(h)) = \int \frac{d^3k}{2\omega(\vec{k})} \frac{1}{e^{\beta\omega(\vec{k})} - 1} \overline{h(\vec{k})} f(\vec{k}), \quad (f, h \in \mathcal{H}). \quad (7.47)$$

In particular, the expected number of particles in a single particle state f (occupation number) is obtained by setting $h = f$. In the limit where the normalized wave packet f concentrates around a wave vector \vec{k}_0 we obtain the thermal spectrum

$$\omega(a^*(f)a(f)) \rightarrow \frac{1}{e^{\beta\omega(\vec{k}_0)} - 1}. \quad (7.48)$$

Note that (7.47) is not Lorentz invariant, since $\omega(\vec{k})$ is not.

Remark. In a curved spacetime with a time-like Killing field the solutions of (7.30) have a definite frequency or are superpositions of such. Thus one might pick \mathcal{H} as the positive frequency subspace and define the vacuum by $N = 0$ on \mathcal{H} (Boulware vacuum). It may though not be the physically correct choice, see (e) below.

d) Regge-Wheeler coordinates. New coordinates $(t, r_*, \theta, \varphi)$ are introduced on the Schwarzschild spacetime (7.13) with $r > 2m$ by the transition function

$$r_* = r + 2m \log\left(\frac{r}{2m} - 1\right)$$

with t, θ, φ fixed. It maps $r \in (2m, \infty) \mapsto r_* \in (-\infty, \infty)$ (tortoise coordinate). Since

$$\frac{dr_*}{dr} = 1 + \left(\frac{r}{2m} - 1\right)^{-1} = \left(1 - \frac{2m}{r}\right)^{-1},$$

the metric reads

$$ds^2 = \left(1 - \frac{2m}{r}\right)(dt^2 - dr_*^2) + r^2(d\theta^2 + \sin^2\theta d\varphi^2) \quad (7.49)$$

with $r = r(r_*)$.

Consider a radially infalling particle crossing the horizon $r_* \rightarrow -\infty, t \rightarrow +\infty$ at proper time $\tau = 0$. There $r = 2m$, whence, see (7.14, 7.15),

$$\dot{r}^2 \cong \mathcal{E}^2, \quad \frac{r-2m}{2m}\dot{t} \cong \mathcal{E}.$$

Thus $r - 2m = -\mathcal{E}\tau$ and $\dot{t} = -\frac{2m}{\tau}$, i.e.,

$$t = -2m \log(-\tau) + \text{const} . \quad (7.50)$$

In particular,

$$r_* = 2m \log\left(-\frac{\mathcal{E}\tau}{2m}\right) + 2m . \quad (7.51)$$

Finally, we write the Klein-Gordon equation in Regge-Wheeler coordinates. After separating the angular part,

$$f(t, r_*, \theta, \varphi) = \sum_{l=0}^{\infty} \sum_{m=-l}^l \frac{f_{lm}(t, r_*)}{r} Y_{lm}(\theta, \varphi) ,$$

it reads (without proof)

$$(\partial_t^2 - \partial_{r_*}^2 + V_l)f_{lm} = 0 ,$$

where the effective potential

$$V_l(r) = \left(1 - \frac{2m}{r}\right) \left(\frac{2m}{r^3} + \frac{l(l+1)}{r^2} + \mu^2\right)$$

has limits

$$V_l(r) \rightarrow \begin{cases} 0, & (r_* \rightarrow -\infty, \text{ i.e. } r \rightarrow 2m) , \\ \mu^2, & (r_* \rightarrow +\infty, \text{ i.e. } r \rightarrow +\infty) . \end{cases}$$

Thus, as $r_* \rightarrow -\infty$, solutions are of the form

$$f_{lm}(t, r_*) = f_{\text{in}}(t - r_*) + f_{\text{out}}(t + r_*) \quad (7.52)$$

with $f_{\text{in}}, f_{\text{out}}$ describing the part of the wave incoming from the white hole, resp. outgoing to the black hole.

e) The expected number of outgoing particles. Consider a wave packet f solving the Klein-Gordon equation in the Schwarzschild metric (7.49), which

- consists of positive frequencies $\approx \omega$ and
- is outgoing at $r_* \rightarrow \infty$ at late times.

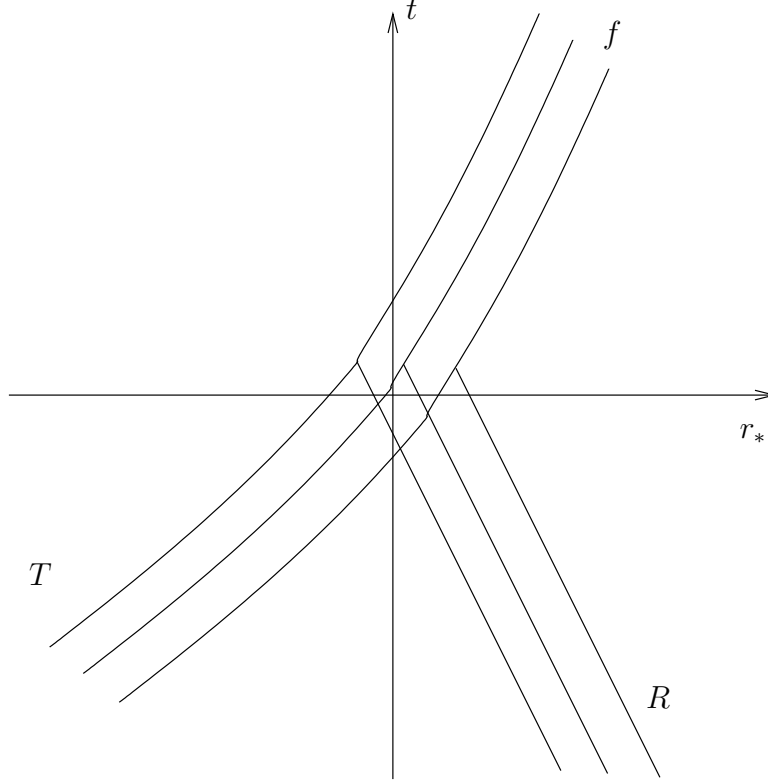

Since for $r_* \rightarrow +\infty$ the metric is Minkowski, f represents a **particle** state at late times. The goal is to compute its occupation number

$$n = \omega(a^*(f)a(f)) .$$

What is ω ? The equivalence principle (see postulate 4 on p. 34) suggests: On states incoming from either $r_* = -\infty$, ($r = 2m$) or $r_* = +\infty$, ($r = +\infty$) and to an observer in free fall there, ω is the Minkowski vacuum (**Unruh vacuum**).

The wave f is not of this form (it is outgoing) but can be split into such,

$$f = T + R ,$$

where T , R are the parts incoming at $r_* = \mp\infty$. They are determined "by scattering f backwards in time", see figure.

An observer with $r_* = r_0$, ($r_0 \rightarrow \infty$) is in free fall; and R , being of positive frequency, is a particle state. Thus

$$\omega(a^*(R)a(R)) = 0$$

and, by (7.38),

$$\omega(a^*(T)a(R)) = 0 , \quad \omega(a^*(R)a(T)) = 0 .$$

Hence

$$n = \omega(a^*(T)a(T)) .$$

By (7.52),

$$T \propto e^{-i\omega(t-r_*)} , \quad (\omega \geq \mu)$$

(or narrow superpositions thereof). For a freely falling observer approaching the horizon $r_* = -\infty$

$$t - r_* \approx -4m \log(-\tau) + \text{const} .$$

by (7.50, 7.51); hence

$$T(\tau) \propto \begin{cases} e^{4im\omega \log(-\tau)} , & (\tau < 0), \\ 0 , & (\tau > 0), \end{cases} \quad (7.53)$$

which is not of positive frequency. Let

$$T = T_+ + T_- \quad (7.54)$$

be its decomposition into positive/negative frequencies w.r.t. τ . Then, based on the Unruh vacuum,

$$\omega(a^*(T_+)a(T_+)) = 0 ,$$

we obtain

$$n = \omega(a^*(T_-)a(T_-)) = \langle T_-, \rho T_- \rangle = -\langle T_-, T_- \rangle ,$$

see (7.40, 7.44) with $N = 0$. It remains to compute the decomposition (7.54) and to this end we may temporarily replace proportionality in (7.53) by equality. The positive frequency part

$$T_+(\tau) = \int_0^\infty \hat{T}_+(w) e^{-iw\tau} dw$$

is analytic in the lower complex half-plane, and $T_-(\tau)$ in the upper one. By analytically continuing

$$T_0(\tau) := e^{4im\omega \log(-\tau)} = e^{4im\omega \log|\tau|} e^{-4m\omega \arg(-\tau)}$$

from $\tau < 0$ to $\tau > 0$ through the lower half-plane we get $T_0(-\tau)e^{-4m\omega\pi}$, whence we tentatively set

$$T_+(\tau) = c_+ \begin{cases} T_0(\tau) , & (\tau < 0), \\ T_0(-\tau)e^{-4m\omega\pi} , & (\tau > 0) . \end{cases}$$

Similarly, continuing through the upper half-plane,

$$T_-(\tau) = c_- \begin{cases} T_0(\tau) , & (\tau < 0) , \\ T_0(-\tau)e^{4m\omega\pi} , & (\tau > 0) . \end{cases}$$

Comparison with (7.53) yields

$$c_+ + c_- = 1 , \quad c_+ e^{-4m\omega\pi} + c_- e^{4m\omega\pi} = 0 ,$$

for $\tau < 0$ and $\tau > 0$ respectively, i.e.

$$c_\pm = \frac{1}{1 - e^{\mp 8\pi m\omega}} .$$

Finally,

$$T_-(\tau) = c_-(T(\tau) + e^{4\pi m\omega} \tilde{T}(\tau)) \quad (7.55)$$

with $\tilde{T}(\tau) = T(-\tau)$. Since

$$\langle T, \tilde{T} \rangle = 0 , \quad \langle \tilde{T}, \tilde{T} \rangle = -\langle T, T \rangle$$

(T, \tilde{T} are non-overlapping, time-reversal changes sign of $\langle \cdot, \cdot \rangle$), we obtain

$$\langle T_-, T_- \rangle = |c_-|^2 (1 - e^{8\pi m \omega}) \langle T, T \rangle = \frac{\langle T, T \rangle}{1 - e^{8\pi m \omega}} ,$$

and hence

$$n = \frac{\langle T, T \rangle}{e^{8\pi m \omega} - 1} .$$

Apart from the "grey-body" factor $\langle T, T \rangle$, which depends on f and hence on ω , this is, cf. (7.48), **black-body radiation** of temperature

$$\beta^{-1} = \frac{1}{8\pi m} = \frac{\hbar c^3}{8\pi G_0 M}$$

(Hawking temperature). The radiation will cause a loss of mass. Since the intensity of black-body radiation is $\propto \beta^{-4}$, black holes of very small mass M evaporate fast.

Note that (7.55) indicates that T_- , which determines the particle content of T , does so through \tilde{T} , which is supported beyond the horizon. This is in agreement with the informal interpretation given at the beginning.

8. The linearized theory of gravity

8.1. The linearized field equations

We discuss spacetimes that are nearly flat. In suitable coordinates their metric reads

$$g_{\mu\nu} = \eta_{\mu\nu} + h_{\mu\nu} \quad (8.1)$$

$$\eta_{\mu\nu} = \begin{pmatrix} 1 & & & \\ & -1 & & \\ & & -1 & \\ 0 & & & -1 \end{pmatrix}, \quad h_{\mu\nu} = h_{\nu\mu}, \quad |h_{\mu\nu}| \ll 1.$$

In linear approximation in h we then have

$$\Gamma^\alpha{}_{\mu\nu} = \frac{1}{2}\eta^{\alpha\beta}(h_{\mu\beta,\nu} + h_{\beta\nu,\mu} - h_{\mu\nu,\beta}) = \frac{1}{2}(h^\alpha{}_{\mu,\nu} + h^\alpha{}_{\nu,\mu} - h_{\mu\nu}{}^{,\alpha}), \quad (8.2)$$

where indices are raised and lowered by means of $\eta_{\mu\nu}$. Moreover,

$$R^\alpha{}_{\mu\beta\nu} = \Gamma^\alpha{}_{\nu\mu,\beta} - \Gamma^\alpha{}_{\beta\mu,\nu},$$

$$R_{\mu\nu} = R^\alpha{}_{\mu\alpha\nu} = \frac{1}{2}(-\square h_{\mu\nu} - h_{,\mu\nu} + h^\alpha{}_{\mu,\alpha\nu} + h^\alpha{}_{\nu,\alpha\mu}),$$

where $h = h^\alpha{}_\alpha$. It is convenient to introduce the perturbation with reversed trace (use $\eta^\mu{}_\mu = 4$)

$$\gamma_{\mu\nu} = h_{\mu\nu} - \frac{1}{2}\eta_{\mu\nu}h, \quad \gamma = \gamma^\alpha{}_\alpha = -h.$$

By

$$h_{\mu\nu} = \gamma_{\mu\nu} - \frac{1}{2}\eta_{\mu\nu}\gamma$$

we get

$$R_{\mu\nu} = \frac{1}{2}(-\square\gamma_{\mu\nu} + \frac{1}{2}\eta_{\mu\nu}\square\gamma + \gamma^\alpha{}_{\mu,\alpha\nu} + \gamma^\alpha{}_{\nu,\alpha\mu}),$$

$$R = \frac{1}{2}(\square\gamma + 2\gamma^{\alpha\beta}{}_{,\alpha\beta}),$$

$$G_{\mu\nu} = R_{\mu\nu} - \frac{1}{2}\eta_{\mu\nu}R = \frac{1}{2}(-\square\gamma_{\mu\nu} - \eta_{\mu\nu}\gamma^{\alpha\beta}{}_{,\alpha\beta} + \gamma^\alpha{}_{\mu,\alpha\nu} + \gamma^\alpha{}_{\nu,\alpha\mu}). \quad (8.3)$$

In this approximation the **field equations** (5.11) are

$$-\square\gamma_{\mu\nu} - \eta_{\mu\nu}\gamma^{\alpha\beta}{}_{,\alpha\beta} + \gamma^\alpha{}_{\mu,\alpha\nu} + \gamma^\alpha{}_{\nu,\alpha\mu} = 2\kappa T_{\mu\nu}. \quad (8.4)$$

Remarks. 1) Eq. (8.3) implies the linearized, contracted 2nd Bianchi identity (3.17)

$$G^{\mu\nu}{}_{,\nu} = 0 \quad (8.5)$$

and thus

$$T^{\mu\nu}{}_{,\nu} = 0. \quad (8.6)$$

2) The field equations (8.4) are **Lorentz covariant**, provided $\gamma_{\mu\nu}$ (resp. $h_{\mu\nu}$) transform as tensor fields, whereby $\eta_{\mu\nu}$ retains the form $\text{diag}(1, -1, -1, -1)$. This latter transformation law follows from that of $g_{\mu\nu}$ by linearization.

3) Eq. (8.4) does not provide a gravitational theory which is compatible with Special Relativity as well as with the Equivalence Principle (EP). Rationale: Let the metric relations be given either by (a) $\eta_{\mu\nu}$ or by (b) $g_{\mu\nu} = \eta_{\mu\nu} + h_{\mu\nu}$. (a) For free falling dust $T^{\mu\nu} = \rho u^\mu u^\nu$ eq. (8.6) and the continuity equation $(\rho u^\nu)_{,\nu} = 0$, cf. (5.2), imply

$$u^\mu u^\nu{}_{,\mu} = 0, \quad (8.7)$$

i.e. the trajectories of dust particles are geodesics of the flat metric $\eta_{\mu\nu}$: matter does not experience any gravity. In case (b) the EP requires

$$T^{\mu\nu}{}_{;\nu} = 0$$

(covariant derivative w.r.t. $g_{\mu\nu}$), which however is incompatible with (8.6); indeed, both equations together imply that the Christoffel symbols vanish, in contradiction with (8.2). In more detail: For dust, $T^{\mu\nu}{}_{;\nu} - T^{\mu\nu}{}_{,\nu} = 0$ implies $0 = u^\mu u^\alpha \Gamma^\nu{}_{\nu\alpha} + u^\alpha u^\nu \Gamma^\mu{}_{\nu\alpha} = u^\alpha u^\beta (\Gamma^\nu{}_{\nu\alpha} \delta_\beta{}^\mu + \Gamma^\nu{}_{\beta\alpha} \delta_\nu{}^\mu)$. Here u is timelike; yet four linearly independent vectors can be inserted, whence the bracket vanishes once it is symmetrized in α, β :

$$\Gamma^\nu{}_{\nu\alpha} \delta_\beta{}^\mu + \Gamma^\nu{}_{\nu\beta} \delta_\alpha{}^\mu + 2\Gamma^\nu{}_{\beta\alpha} \delta_\nu{}^\mu = 0.$$

The $\beta\mu$ -trace yields $(4 + 1 + 2)\Gamma^\nu{}_{\nu\alpha} = 0$ and thus $\Gamma^\mu{}_{\beta\alpha} = 0$.

8.2. Gauge transformations and gauges

The linearized field equations (8.4) are **gauge covariant**, reflecting the general covariance of the field equations. Infinitesimal gauge transformations are $g \rightarrow g + L_\xi g$, where ξ^μ is an arbitrary vector field. In connection with (8.1) they read $h \rightarrow h + L_\xi \eta$ (**gauge transformations**), where $L_\xi h$ is neglected as a 2nd order term:

$$\begin{aligned} h_{\mu\nu} &\rightarrow h_{\mu\nu} + \xi_{\mu,\nu} + \xi_{\nu,\mu}, \\ \gamma_{\mu\nu} &\rightarrow \gamma_{\mu\nu} + \xi_{\mu,\nu} + \xi_{\nu,\mu} - \eta_{\mu\nu} \xi^\alpha{}_{,\alpha} \end{aligned} \quad (8.8)$$

and in particular

$$\gamma \rightarrow \gamma - 2\xi^\alpha{}_{,\alpha}. \quad (8.9)$$

Moreover $T^{\mu\nu} \rightarrow T^{\mu\nu}$, since the change is of higher order. The claimed covariance of (8.4) follows from

$$\Gamma^\alpha{}_{\mu\nu} \rightarrow \Gamma^\alpha{}_{\mu\nu} + \xi^\alpha{}_{,\mu\nu}, \quad R^\alpha{}_{\mu\beta\nu} \rightarrow R^\alpha{}_{\mu\beta\nu} + \underbrace{\xi^\alpha{}_{,\nu\mu\beta} - \xi^\alpha{}_{,\beta\mu\nu}}_{=0}. \quad (8.10)$$

The latter once more, but without use of coordinates: Let $R[g]$ be the Riemann tensor of g . The linearized Riemann tensor $R^{(1)}[g]$ is characterized by

$$R[g + f] = R[g] + R^{(1)}[g](f) + O(f^2) \quad (f \rightarrow 0),$$

where $R^{(1)}[g](f)$ is linear in f . Let φ_s be the flow generated by ξ . From $\varphi_s^* R[g] = R[\varphi_s^* g]$ we have

$$\begin{aligned} L_X R[g] &= R^{(1)}[g](L_X g) \\ &= R^{(1)}[g](h + L_X g) - R^{(1)}[g](h) . \end{aligned}$$

For $g = \eta$ we have $R[\eta] = 0$ and (8.10) is seen to be gauge invariant,

$$R^{(1)}[\eta](h + L_X \eta) = R^{(1)}[\eta](h) .$$

We shall reduce the **gauge freedom** (8.8) step by step by means of ever more special **gauges**.

i) **Hilbert gauge** (cf. Lorenz gauge in Electrodynamics)

$$\gamma^{\mu\nu}{}_{,\nu} = 0 . \quad (8.11)$$

Starting from $\bar{\gamma}^{\mu\nu}$, it can be achieved by solving

$$\bar{\gamma}^{\mu\nu}{}_{,\nu} + \xi^{\mu,\nu}{}_{,\nu} + \underbrace{\xi^{\nu,\mu}{}_{,\nu} - \eta^{\mu\nu} \xi^{\alpha}{}_{,\alpha\nu}}_{=0} = 0$$

i.e.

$$\square \xi^\mu = -\bar{\gamma}^{\mu\nu}{}_{,\nu} .$$

This inhomogeneous wave equation can be solved, cf. retarded or advanced Green's functions in Electrodynamics. We are left with residual gauge transformations satisfying

$$\square \xi^\mu = 0 . \quad (8.12)$$

No longer can the whole field $\xi^\mu(x)$ be chosen freely, but only the initial conditions ξ^μ , $\xi^\mu{}_{,0}$ at time $x^0 = 0$, which uniquely determine the solution of (8.12).

The field equations (8.4) take in this gauge (8.11) the simpler form

$$-\square \gamma_{\mu\nu} = 2\kappa T_{\mu\nu} . \quad (8.13)$$

Remarks: 1) The integrability condition $T^{\mu\nu}{}_{,\nu} = 0$ now follows from (8.11).

2) It is manifest from (8.13) that gravitational waves propagate at the velocity of light.

ii) In **vacuum** ($T^{\mu\nu} = 0$) or more generally if $T^\mu{}_\mu = 0$ we have $\square \gamma = 0$. In addition to (8.11) one can enforce the traceless gauge

$$\gamma = 0 . \quad (8.14)$$

Starting from $\bar{\gamma}^{\mu\nu}$ in the gauge (8.11), one can achieve it by solving (cf. (8.9))

$$\xi^\alpha{}_{,\alpha} = \frac{1}{2} \bar{\gamma} \quad (8.15)$$

together with (8.12). This is doable: Any solution of the latter equation has $\square \xi^\alpha{}_{,\alpha} = 0$, and $\square \bar{\gamma} = 0$ holds true anyhow. Hence (8.15) follows as soon as the initial conditions at $x^0 = 0$ of the following two equations agree:

$$\xi^\alpha{}_{,\alpha} \equiv \xi^0{}_{,0} + \xi^i{}_{,i} = \frac{1}{2} \bar{\gamma} , \quad (8.16)$$

$$\partial^0 \xi^\alpha{}_{,\alpha} \equiv \Delta \xi^0 + \xi^{i,0}{}_{,i} = \frac{1}{2} \bar{\gamma}_{,0} . \quad (8.17)$$

These equations can be solved for ξ^μ and $\xi^\mu_{,0}$, though not uniquely. There thus still remain residual gauge transformations with (8.12) and

$$\xi^\alpha_{, \alpha} = 0 \quad (8.18)$$

(volume preserving coordinate transformations). In the gauge (8.14) we also have

$$h_{\mu\nu} = \gamma_{\mu\nu} .$$

iii) **Radiation gauge** or TT (Transverse Traceless) gauge (cf. Coulomb gauge for $j^\mu = 0$ in Electrodynamics). One requires in addition

$$h^{0\mu} = 0 . \quad (8.19)$$

In this gauge (resp. coordinates) the metric deformation (8.1) occurs only in spatial directions, but not in the time direction. Moreover

$$R^i{}_{00j} = \Gamma^i{}_{j0,0} - \underbrace{\Gamma^i{}_{00,j}}_{=0} = \frac{1}{2} h^i{}_{j,00} = -\frac{1}{2} h_{ij,00} . \quad (8.20)$$

Starting from $\bar{h}^{\mu\nu}$ with (8.11, 8.14) one can achieve (8.19) by solving (8.12, 8.18) as well as

$$h^{00} \equiv \bar{h}^{00} + 2\xi^{0,0} = 0 , \quad (8.21)$$

$$h^{0i} \equiv \bar{h}^{0i} + \xi^{0,i} + \xi^{i,0} = 0 . \quad (8.22)$$

This too is doable: Solutions of (8.12), or rather their initial conditions $\xi^\mu, \xi^{\mu,0}$ at time $x^0 = 0$, need to satisfy besides of (8.21, 8.22) also

$$\bar{h}^{00}{}_{,0} + 2\Delta\xi^0 = 0 , \quad (8.23)$$

$$\bar{h}^{0i}{}_{,0} + \xi^{0,i}{}_{,0} + \Delta\xi^i = 0 , \quad (8.24)$$

as well as (8.16, 8.17) with $\bar{\gamma} = 0$. Eqs. (8.21, 8.23) determine the initial conditions $\xi^{0,0}$ and ξ^0 ; then $\xi^{i,0}$ follows from (8.22), which is seen to satisfy (8.17):

$$\Delta\xi^0 - \bar{h}^{0i}{}_{,i} - \xi^{0,i}{}_{,i} = \Delta\xi^0 + \bar{h}^{00}{}_{,0} + \Delta\xi^0 = 0 .$$

There remain the eqs. (8.24, 8.16) for ξ^i . They are of the form $\Delta\xi^i = a^i$, $\text{div } \vec{\xi} = b$, which is solvable, provided the compatibility condition $\text{div } \vec{a} = \Delta b$ holds true. In the present case

$$\begin{aligned} a^i &= -\bar{h}^{0i}{}_{,0} - \frac{1}{2}\bar{h}^{00}{}_{,i} , & b &= -\frac{1}{2}\bar{h}^{00} , \\ \text{div } \vec{a} &= -\bar{h}^{0i}{}_{,0i} - \frac{1}{2}\bar{h}^{00}{}_{,ii} , & \Delta b &= \frac{1}{2}\bar{h}^{00}{}_{,ii} , \end{aligned}$$

that condition is satisfied because of (8.11).

8.3. Gravitational waves

In the radiation gauge we have

$$\begin{aligned} h^{\mu 0} &= 0, & h^i{}_i &= 0, \\ h^{ij}{}_{,j} &= 0 \end{aligned} \tag{8.25}$$

and the field equations in vacuum read

$$\square h_{ij} = 0.$$

Plane waves are solutions of the form

$$h_{ij} = h_{ij}(s), \quad |\vec{e}| = 1$$

with functions $h_{ij}(s)$ of the variable $s = \vec{e} \cdot \vec{x} - t$. The gauge (8.25) states

$$\frac{dh_{ij}}{ds} e^j = 0, \tag{8.26}$$

and even $h_{ij}(s)e^j = 0$ if the wave is of finite duration.

Motion of test particles: Let $u^\mu = (1, \vec{0})$ be the 4-velocity of a particle which at proper time $\tau = 0$ is at rest in the TT coordinate system. In free fall one always has $u^\mu(\tau) = (1, \vec{0})$, since this solves the geodesic equation $du^\mu/d\tau + \Gamma^\mu{}_{\nu\sigma} u^\nu u^\sigma = 0$, because of $\Gamma^\mu{}_{00} = 0$, cf. (8.2, 8.19). The worldline is $x^\mu(\tau) = (\tau, \vec{x}_0)$; nearby particles have fixed coordinate differences $n^\mu = (0, \vec{n})$, yet variable distance since by (8.1) we have

$$(n, n) = -\vec{n}^2 + h_{ij}(s)n^i n^j.$$

Alternatively the same follows by the eq. (4.22) of geodesic deviation

$$\begin{aligned} \frac{d^2}{dt^2}(n, n) &= \nabla_u^2(n, n) = 2(\nabla_u^2 n, n) + 2 \underbrace{(\nabla_u n, \nabla_u n)}_{O(h^2)} \\ &= 2(R(u, n)u, n) = -2R^i{}_{00j} n^j n^i = \frac{1}{2} \frac{d^2 h_{ij}}{ds^2} n^i n^j, \end{aligned}$$

by (8.20). Or still put differently: In the coordinates

$$\tilde{x}^\mu = x^\mu + \frac{1}{2} h^\mu{}_\nu x^\nu$$

(note $\tilde{x}^0 = x^0$) the metric reads $\tilde{g}_{\mu\nu} = \eta_{\mu\nu} + O(h^2) + O(\vec{x}/\lambda)$, where λ is a characteristic length scale of the wave. This follows from

$$\begin{aligned} \frac{\partial \tilde{x}^\mu}{\partial x^\sigma} &= \delta^\mu{}_\sigma + \frac{1}{2} h^\mu{}_\sigma + \frac{1}{2} \frac{\partial h^\mu{}_i}{\partial x^\sigma} x^i = \delta^\mu{}_\sigma + \frac{1}{2} h^\mu{}_\sigma + O(\vec{x}/\lambda), \\ \eta_{\mu\nu} d\tilde{x}^\mu d\tilde{x}^\nu &= \eta_{\mu\nu} \left(\delta^\mu{}_\sigma + \frac{1}{2} h^\mu{}_\sigma \right) \left(\delta^\nu{}_\rho + \frac{1}{2} h^\nu{}_\rho \right) dx^\sigma dx^\rho = (\eta_{\sigma\rho} + h_{\sigma\rho}) dx^\sigma dx^\rho + O(h^2). \end{aligned}$$

In a small neighborhood of the geodesic $\tilde{x}^\mu(\tau) = (\tau, 0)$ the coordinates \tilde{x}^μ do have the meaning of distances in space and time, cf. p. 34. The deviation between nearby particles is now time-dependent:

$$\Delta\tilde{n}^i(t) = -\frac{1}{2}h_{ij}(s)\tilde{n}^j .$$

This vanishes for $\tilde{n}^j = e^j$ by (8.26): There are no oscillations in the direction of propagation, meaning that gravitational waves are **transversal**. For monochromatic waves we have

$$h_{ij}(s) = \varepsilon_{ij}e^{i\omega s} , \quad (\omega > 0),$$

where the physical field is actually the real part of it. The complex amplitude ε_{ij} is arbitrary in the 2-dimensional complex vector space

$$\{\varepsilon_{ij} \in \mathbb{C}^2 \mid \varepsilon_{ij} = \varepsilon_{ji}, \varepsilon^i_i = 0, \varepsilon_{ij}e^j = 0\} .$$

By choosing $e = e_3$ in the 3-direction, only the components

$$\varepsilon = \begin{pmatrix} \varepsilon_{11} & \varepsilon_{12} \\ \varepsilon_{12} & \varepsilon_{-11} \end{pmatrix} = \text{Re } \varepsilon + i \text{Im } \varepsilon$$

are non-zero. $\text{Re } \varepsilon$ and $\text{Im } \varepsilon$ are symmetric matrices. The **polarization** of the wave is represented by the displacement $\tilde{n} + \Delta\tilde{n}(t)$, (\sim omitted) of test particles with \tilde{n} on the unit circle in the plane $\perp \vec{e}$ (see figure):

$$\Delta\tilde{n}(t) = -\frac{1}{2} [(\text{Re } \varepsilon)\tilde{n} \cos \omega t + (\text{Im } \varepsilon)\tilde{n} \sin \omega t] .$$

Special cases:

1) **linear polarization:**

$$\text{Re } \varepsilon \parallel \text{Im } \varepsilon$$

(i.e. $\text{Re } \varepsilon, \text{Im } \varepsilon$ equal up to a factor). Relatively to the eigenbasis $e_1 \perp e_2$ of ε we have

$$\varepsilon = A \begin{pmatrix} 1 & 0 \\ 0 & -1 \end{pmatrix} , \quad (A \in \mathbb{C}) ,$$

$$\Delta\tilde{n}(t) = \frac{1}{2} \begin{pmatrix} -u_1 \\ u_2 \end{pmatrix} ((\text{Re } A) \cos \omega t + (\text{Im } A) \sin \omega t) .$$

2) **right/left circular polarization:**

$$\text{Im } \varepsilon = \pm R(\text{Re } \varepsilon)R^T = \pm \text{Re} \begin{pmatrix} -\varepsilon_{12} & \varepsilon_{11} \\ \varepsilon_{11} & \varepsilon_{12} \end{pmatrix}$$

where R is a rotation by $\pi/4$. In the eigenbasis $e_1 \perp e_2$ of $\text{Re } \varepsilon$ we have

$$\varepsilon = A \begin{pmatrix} 1 & \pm i \\ \pm i & -1 \end{pmatrix} , \quad (A \in \mathbb{R}) ,$$

$$\Delta\tilde{n}(t) = \frac{1}{2} A \left[\begin{pmatrix} -n_1 \\ n_2 \end{pmatrix} \cos \omega t \mp \begin{pmatrix} n_2 \\ n_1 \end{pmatrix} \sin \omega t \right] .$$

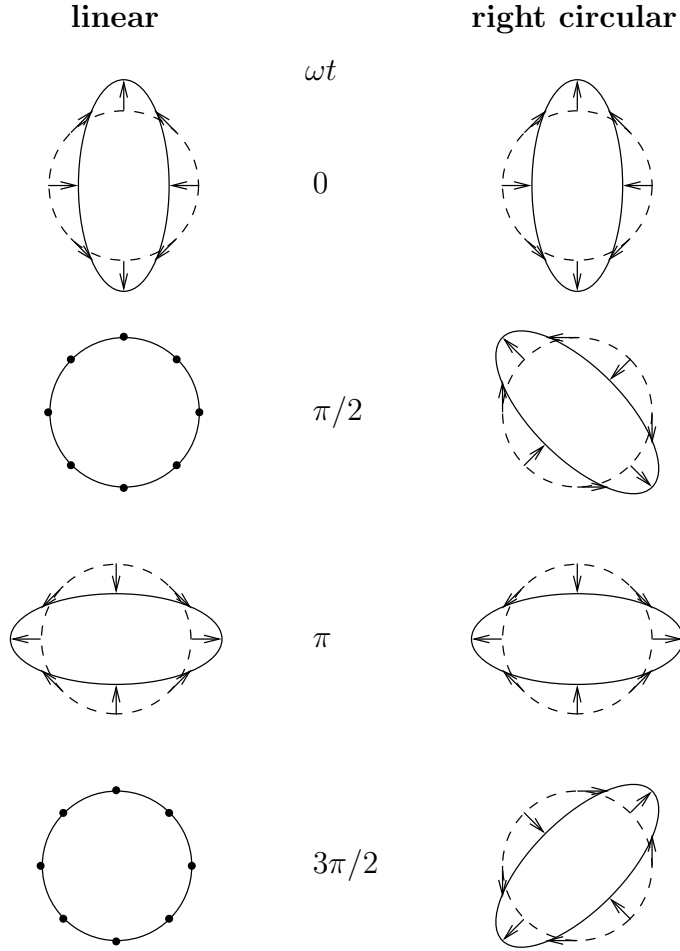

Under a rotation $R_\varphi = \begin{pmatrix} \cos \varphi & -\sin \varphi \\ \sin \varphi & \cos \varphi \end{pmatrix}$ the polarization ε transforms to

$$R_\varphi \varepsilon R_\varphi^T = e^{\mp 2i\varphi} \varepsilon .$$

One says the wave has **helicity** ± 2 (cf. electromagnetic waves: ± 1).

Remark. Particles that are not in free fall experience further forces besides of tidal ones. Application: Gravitational wave detectors (LIGO, VIRGO, GEO). Mirrors oscillate with the forcing frequency of the gravitational wave.

8.4. Emission of radiation

The energy-momentum tensor of gravitation. The linearized Einstein tensor $G^{(1)}[\eta](h)$, cf. (8.3), is the term linear in h in the expansion

$$G[\eta + h] = G^{(1)}[\eta](h) + O(h^2) , \quad (h \rightarrow 0) .$$

The full field equations (5.10) may be written as

$$\begin{aligned} G^{(1)}[\eta](h) &= \kappa T - (G[\eta + h] - G^{(1)}[\eta](h)) \\ &= \kappa(T + t) , \end{aligned} \tag{8.27}$$

where

$$t = -\kappa^{-1}(G[\eta + h] - G^{(1)}[\eta](h)) .$$

From the viewpoint of the full theory, the splitting $G = G^{(1)} + (G - G^{(1)})$ is arbitrary, which is e.g. reflected in that $\eta = \text{diag}(1, -1, -1, -1)$ (and hence $G^{(1)}[\eta](h)$ and t) are not tensors under general coordinate transformations. From the point of view of the linearized theory, where $G^{(1)}[\eta](h)$ is the relevant curvature, the full equations (8.27) state that the gravitational field is a source of its own curvature, besides of matter. One can therefore regard $t^{\mu\nu}$ as energy-momentum tensor of the gravitational field. This is further justified by $(T^{\mu\nu} + t^{\mu\nu})_{,\nu} = 0$, cf. (8.5, 8.27): Energy and momentum of matter and gravitation are jointly conserved. Note that this is exact, in contrast to (8.6) valid in the linearized theory. To lowest order, $t^{\mu\nu}$ is quadratic in h ,

$$\kappa t = -\frac{1}{2}G^{(2)}[\eta](h, h) ,$$

resp. after a longer computation

$$4\kappa t_{\mu\nu} = \gamma_{\alpha\beta,\mu}\gamma^{\alpha\beta}{}_{,\nu} - \frac{1}{2}\gamma_{,\mu}\gamma_{,\nu} \underbrace{-\gamma^{\alpha\beta}{}_{,\beta}\gamma_{\alpha\mu,\nu} - \gamma^{\alpha\beta}{}_{,\beta}\gamma_{\alpha\nu,\mu}}_{=0} , \quad (8.28)$$

where the underbrace applies to the Hilbert gauge (8.11). Thus: Even though t is neglected in the linearized field equations, it can be computed from their solution $\gamma_{\mu\nu}$.

Emission of gravitational waves. A spatially localized source $T^{\mu\nu}$ with (8.6) generates the retarded solution of the field equations (8.13):

$$\gamma^{\mu\nu}(x) = -2\kappa \int d^4y D_{\text{ret}}(x - y) T^{\mu\nu}(y) ,$$

where $D_{\text{ret}}(x) = \delta(x^0 - r)/4\pi r$, ($r = |\vec{x}|$) is the Green's function of the wave equation (s. Electrodynamics), and thus

$$\gamma^{\mu\nu}(\vec{x}, t) = -\frac{2\kappa}{4\pi} \int d^3y \frac{T^{\mu\nu}(\vec{y}, t - |\vec{x} - \vec{y}|)}{|\vec{x} - \vec{y}|} .$$

The Hilbert gauge (8.11) is satisfied, but $\gamma \neq 0$ as a rule. The retardation entails that $\gamma^{\mu\nu}{}_{,\alpha}$ decays as r^{-1} , and $t^{\mu\nu}$ as r^{-2} : The energy flow in a fixed solid angle attains a limit as $r \rightarrow \infty$ (emission). We compute the terms $\sim r^{-1}$ of $\gamma^{\mu\nu}$ under the assumption

$$r \gg \lambda \gg d ,$$

where d the extension of the source and λ is a characteristic length (\approx wavelength), e.g. $\lambda = 2\pi/\omega$, ($c = 1$). We then have to leading order in r^{-1}

$$\gamma^{\mu\nu}(\vec{x}, t) = -\frac{\kappa}{2\pi r} \int d^3y T^{\mu\nu}(\vec{y}, t - |\vec{x} - \vec{y}|) \quad (8.29)$$

and likewise for its derivatives. Using $|\vec{x} - \vec{y}| = r + O(d)$ this is further expanded in d/λ as

$$\gamma^{\mu\nu}(\vec{x}, t) = -\frac{\kappa}{2\pi r} \underbrace{\int d^3y T^{\mu\nu}(\vec{y}, t - r)}_{\varepsilon^{\mu\nu}(t-r)} + \frac{1}{r} O(d/\lambda) , \quad (8.30)$$

The components $\varepsilon^{\mu\nu}(s)$ are functions of the variables $s = t - r$ and can be expressed by T^{00}

$$\varepsilon^{00}(t) = \int d^3y T^{00}(\vec{y}, t), \quad \varepsilon^{i0}(t) = \frac{d}{dt} \int d^3y T^{00}(\vec{y}, t) y^i, \quad (8.31)$$

$$\varepsilon^{ij}(t) = \frac{1}{2} \frac{d^2}{dt^2} \int d^3y T^{00}(\vec{y}, t) y^i y^j. \quad (8.32)$$

Relatively to ε^{00} , we thus have $\varepsilon^{i0} = O(d/\lambda)$ since $y^i \sim d$ and $d/dt \sim \omega \sim \lambda^{-1}$; likewise $\varepsilon^{ij} = O((d/\lambda)^2)$. As for eq. (8.32): For arbitrary $\vec{u}, \vec{v} \in \mathbb{R}^3$ (with scalar product denoted (\vec{u}, \vec{v})) we have

$$\begin{aligned} \frac{1}{2}(u_i v_j + u_j v_i) &= \partial_i \partial_j \frac{1}{2}(\vec{u}, \vec{y})(\vec{v}, \vec{y}), \\ \varepsilon^{ij} u_i v_j &= \int d^3y T^{ij} u_i v_j = \frac{1}{2} \int d^3y T^{ij}{}_{,ji}(\vec{u}, \vec{y})(\vec{v}, \vec{y}) \\ &= \frac{1}{2} \frac{d^2}{dt^2} \int d^3y T^{00} y^i y^j u_i v_j, \end{aligned}$$

where we used (8.6): $T^{ij}{}_{,ji} = -T^{i0}{}_{,0i} = -T^{0i}{}_{,i0} = T^{00}{}_{,00}$. The components (8.31), which are established similarly, are actually constant ($\cdot = d/dt$),

$$\dot{\varepsilon}^{\mu 0}(t) = 0, \quad (8.33)$$

since

$$\dot{\varepsilon}^{\mu 0} = \int d^3y T^{\mu 0}{}_{,0} = - \int d^3y T^{\mu i}{}_{,i} = 0.$$

Remark (informal). Let us view T^{00} as a (non-relativistic) mass distribution. The components (8.31) stand for its total mass and for the center of mass (or total) momentum; their conservation is expressed by (8.33). This is to be contrasted with Electrodynamics, where the total charge $e = \int d^3y \rho(\vec{y}, t)$ of a distribution is conserved, but \vec{p} is not, $p^i = \int d^3y \rho(\vec{y}, t) y^i$ being its dipole moment. Recall that an electric monopole does not radiate ($\dot{e} = 0$), but a dipole does according to $\ddot{\vec{p}}$. We anticipate by analogy that the lowest order contribution to gravitational radiation comes from the quadrupole, and in fact according to $\ddot{\ddot{Q}}$.

Differentiating (8.30) yields to leading order in d/λ

$$\gamma^{ij}{}_{,0} = -\frac{\kappa}{2\pi r} \dot{\varepsilon}^{ij}, \quad (8.34)$$

this being $O((d/\lambda)^2)$ on the scale of $(r\lambda)^{-1}$ and not vanishing as a rule. Proceeding likewise with $\gamma^{\mu 0}{}_{,0}$ produces a vanishing leading term by (8.33), formally of order $O(1)$ or $O(d/\lambda)$ on that same scale. This means that a subleading term takes over which, though down by $O(d/\lambda)$ or more, remains comparable in size to (8.34). To compute $\gamma^{\mu 0}{}_{,0}$ we better return to (8.29): We have

$$\gamma^{\mu\nu}{}_{,i} = -\gamma^{\mu\nu}{}_{,0} e^i, \quad (\vec{e} = \vec{x}/r) \quad (8.35)$$

since the leading contribution arises through the retardation by $\partial_i |\vec{x} - \vec{y}| = e^i + O(r^{-1})$. From the gauge condition (8.11) we have $\gamma^{\mu 0}{}_{,0} = -\gamma^{\mu i}{}_{,i}$ and in particular

$$\gamma^{\mu 0}{}_{,0} = \gamma^{\mu i}{}_{,0} e^i, \quad \gamma^{00}{}_{,0} = \gamma^{ij}{}_{,0} e^i e^j.$$

The energy current density $t^{0i}e^i = -t_{0i}e^i$ in direction \vec{e} is by (8.28, 8.35)

$$4\kappa t^{0i}e^i = (\dot{\gamma}_{\alpha\beta}\dot{\gamma}^{\alpha\beta} - \frac{1}{2}\dot{\gamma}^2) \underbrace{\sum_{i=1}^3 (e^i)^2}_{=1} .$$

Denoting by $\underline{\gamma} = (\gamma_{ij})$ the space-space components of $\gamma_{\mu\nu}$ we have

$$\begin{aligned} \dot{\gamma}_{\alpha\beta}\dot{\gamma}^{\alpha\beta} &= \text{tr } \dot{\underline{\gamma}}^2 - 2 \sum_{i=1}^3 (\dot{\gamma}^{i0})^2 + (\dot{\gamma}^{00})^2 \\ &= \text{tr } \dot{\underline{\gamma}}^2 - 2(\dot{\underline{\gamma}}\vec{e}, \dot{\underline{\gamma}}\vec{e}) + (\vec{e}, \dot{\underline{\gamma}}\vec{e})^2 , \\ \dot{\gamma} &= \dot{\gamma}_{;\alpha}^{\alpha} = -\text{tr } \dot{\underline{\gamma}} + \dot{\gamma}^{00} = -\text{tr } \dot{\underline{\gamma}} + (\vec{e}, \dot{\underline{\gamma}}\vec{e}) \end{aligned}$$

and after a short computation

$$\dot{\gamma}_{\alpha\beta}\dot{\gamma}^{\alpha\beta} - \frac{1}{2}\dot{\gamma}^2 = \text{tr } \dot{\underline{\gamma}}^2 - 2(\dot{\underline{\gamma}}\vec{e}, \dot{\underline{\gamma}}\vec{e}) + \frac{1}{2}(\vec{e}, \dot{\underline{\gamma}}\vec{e})^2 ,$$

where $\hat{\gamma}$ is the traceless part of $\underline{\gamma}$. Using (8.34) it is expressed by $\hat{\varepsilon}$ similarly defined:

$$\hat{\varepsilon} = \underline{\varepsilon} - \frac{1}{3}(\text{tr } \underline{\varepsilon})\text{id} = \frac{1}{6}\ddot{Q} ,$$

where, cf. (8.32),

$$Q_{ij}(t) = \int d^3y T^{00}(\vec{y}, t)(3y^i y^j - \delta^{ij} \vec{y}^2)$$

is the **quadrupole tensor** of the mass distribution. The power radiated in the solid angle de ,

$$dI = r^2 t^{0i} e^i de ,$$

is

$$\frac{dI}{de} = \frac{\kappa}{576\pi^2} (\text{tr } \ddot{Q}^2 - 2(\vec{e}, \ddot{Q}^2 \vec{e}) + \frac{1}{2}(\vec{e}, \ddot{Q}^2 \vec{e})^2) .$$

Using that

$$\int de (\vec{e}, Q^2 \vec{e}) = \frac{4\pi}{3} \text{tr } Q^2 , \quad \int de (\vec{e}, Q \vec{e})^2 = \frac{8\pi}{15} \text{tr } Q^2$$

the total emitted power is computed as (Einstein 1917)

$$I = \frac{\kappa}{360\pi c^5} \text{tr } \ddot{Q}^2 \tag{8.36}$$

(where c is again $\neq 1$).

Application to binary stars: Shortening of the orbital period as a result of radiation losses (units: $G = \kappa/8\pi = c = 1$). The orbit of the two stars around their common center of mass can be described within Newton's theory. Summary:

- dynamical parameters: m_1, m_2 masses of the two bodies; $M = m_1 + m_2$ total mass; $m = m_1 m_2 / M$ reduced mass; $E < 0$ energy; T period.

- geometric parameters: a semi-major axis of ellipse; ε excentricity; $p = a(1 - \varepsilon^2)$ “parameter”.

- Newton’s law:

$$\ddot{\vec{r}} = -\frac{M}{r^3}\vec{r}, \quad (\vec{r} = \vec{r}_1 - \vec{r}_2).$$

- Kepler’s law of the orbit (r, φ) :

$$\begin{aligned} \text{i)} \quad & u \equiv \frac{1}{r} = \frac{1 + \varepsilon \cos \varphi}{p} \\ \text{ii)} \quad & r^2 \dot{\varphi} = (pM)^{1/2} \\ \text{iii)} \quad & T = \frac{2\pi a^{3/2}}{M^{1/2}}. \end{aligned}$$

Moreover,

$$-E = \frac{mM}{2a}. \quad (8.37)$$

Relatively to the center of mass one has $\vec{r}_1 = (m_2/M)\vec{r}$, $\vec{r}_2 = -(m_1/M)\vec{r}$. The moment of inertia of the system is thus

$$\theta = \int d^3x \rho(\vec{x}) \vec{x} \otimes \vec{x} = \frac{1}{M^2} \underbrace{(m_1 m_2^2 + m_2 m_1^2)}_{m_1 m_2 M} \vec{r} \otimes \vec{r} = m \vec{r} \otimes \vec{r}.$$

We shall compute

$$\ddot{\theta} = m(\ddot{\vec{r}} \otimes \vec{r} + 3\dot{\vec{r}} \otimes \dot{\vec{r}} + 3\dot{\vec{r}} \otimes \ddot{\vec{r}} + \vec{r} \otimes \ddot{\vec{r}}).$$

Let $\vec{e}_r, \vec{e}_\varphi$ be unit vectors in radial, resp. tangential directions. By means of

$$\begin{aligned} \vec{r} &= r \vec{e}_r, & \dot{\vec{r}} &= \dot{r} \vec{e}_r + r \dot{\varphi} \vec{e}_\varphi, \\ \ddot{\vec{r}} &= -\frac{M}{r^2} \vec{e}_r, & \ddot{\vec{r}} &= M \left(\frac{3}{r^4} \dot{r} \vec{r} - \frac{\dot{\vec{r}}}{r^3} \right) = M \left(\frac{2\dot{r}}{r^3} \vec{e}_r - \frac{\dot{\varphi}}{r^2} \vec{e}_\varphi \right) \end{aligned}$$

we obtain

$$\begin{aligned} \ddot{\vec{r}} \otimes \vec{r} &= M \left(\frac{2}{r^2} \dot{r} \vec{e}_r \otimes \vec{e}_r - \frac{\dot{\varphi}}{r} \vec{e}_\varphi \otimes \vec{e}_r \right), \\ \dot{\vec{r}} \otimes \dot{\vec{r}} &= -M \left(\frac{\dot{r}}{r^2} \vec{e}_r \otimes \vec{e}_r + \frac{\dot{\varphi}}{r} \vec{e}_r \otimes \vec{e}_\varphi \right), \\ \ddot{\theta} &= -mM \left(\underbrace{2 \frac{\dot{r}}{r^2} \vec{e}_r \otimes \vec{e}_r}_{-\dot{u}} + 4 \frac{\dot{\varphi}}{r} (\vec{e}_r \otimes \vec{e}_\varphi + \vec{e}_\varphi \otimes \vec{e}_r) \right), \end{aligned}$$

as well as

$$\text{tr } \ddot{\theta} = 2mM\dot{u}, \quad \text{tr } \ddot{\theta}^2 = 4(mM)^2(\dot{u}^2 + 8u^2\dot{\varphi}^2).$$

For the quadrupole tensor

$$Q = 3\theta - (\text{tr } \theta)\text{id}$$

one then finds

$$\begin{aligned} \text{tr } \ddot{Q}^2 &= 3(3 \text{tr } \ddot{\theta}^2 - (\text{tr } \ddot{\theta})^2) \\ &= 12(mM)^2(2\dot{u}^2 + 24u^2\dot{\varphi}^2) \\ &= 24 \left(\frac{mM}{p} \right)^2 (\varepsilon^2 \sin^2 \varphi + 12(1 + \varepsilon \cos \varphi)^2) \dot{\varphi}^2. \end{aligned}$$

The energy loss is given by the radiative power (8.36):

$$-\frac{dE}{dt} = \frac{1}{45} \text{tr} \ddot{Q}^2 .$$

Averaged over a period it amounts to

$$\begin{aligned} -\left\langle \frac{dE}{dt} \right\rangle &= \frac{1}{T} \int_0^T \left(-\frac{dE}{dt} \right) dt = \frac{1}{T} \int_0^{2\pi} \left(-\frac{dE}{dt} \right) \frac{d\varphi}{\dot{\varphi}} \\ &= \frac{1}{T} \cdot \frac{8}{15} \left(\frac{mM}{p} \right)^2 \frac{(pM)^{1/2}}{p^2} \underbrace{\int_0^{2\pi} (\varepsilon^2 \sin^2 \varphi + 12(1 + \varepsilon \cos \varphi)^2)(1 + \varepsilon \cos \varphi)^2 dy}_{24\pi \left(1 + \frac{73}{24} \varepsilon^2 + \frac{37}{96} \varepsilon^4 \right)} , \end{aligned}$$

where the last equality uses the Kepler laws (i, ii) to express $\dot{\varphi}$. The law (iii) and (8.37) imply

$$-ET = \pi m (Ma)^{1/2} ,$$

as well as the shortening of the period

$$\begin{aligned} \frac{\dot{T}}{T} &= \frac{3 \dot{a}}{2a} = -\frac{3 \dot{E}}{2E} \\ &= -\frac{96 mM^2}{5 a^4} (1 - \varepsilon^2)^{-7/2} \left(1 + \frac{73}{24} \varepsilon^2 + \frac{37}{96} \varepsilon^4 \right) . \end{aligned}$$

This prediction has been experimentally confirmed (Hulse and Taylor 1975, Nobel prize 1993) on the basis of the binary star consisting of the pulsar PSR 1913 + 16 and of an invisible partner (both neutron stars):

Theory:

$$\dot{T} = (-2.40247 \pm 0.00002) \times 10^{-12}$$

Observation:

$$\dot{T} = (-2.4086 \pm 0.0052) \times 10^{-12} .$$

The agreement is within 0.5%.

Literature:

- P.A.M. Dirac, “General Theory of Relativity”, Wiley 1973
- J.B. Hartle, “Gravity. An Introduction to Einstein’s General Relativity”, Addison Wesley 2003
- C.W. Misner, K.S. Thorne, J.A. Wheeler, “Gravitation”, Freeman 1973
- W. Pauli, “Theory of Relativity”, Pergamon 1958
- W. Rindler, “Essential Relativity”, Springer 1977
- R.K. Sachs, H. Wu, “General Relativity for Mathematicians”, Springer 1977
- N. Straumann, “General Relativity With Applications to Astrophysics”, Springer 2004
- R.M. Wald, “General Relativity”, University of Chicago Press, 1984
- S. Weinberg, “Gravitation and Cosmology”, Wiley 1972