



# Maxwell's Demon

Critique of existing research literature

Speaker: Corsin Pfister



# What you have heard so far

- Szilard's principle of entropy generation due to information acquisition (measurement)
- Brillouin: measurement with photons; the negentropy principle
- Landauer's erasure principle
- Bennett's argument



# What is an exorcism?

- **exorcism:** a scientific paper whose aim is to save the Second Law of thermodynamics by finding arguments which prevent Maxwell's Demon from violating the Second Law

I will also use the following notion:

- **successful exorcism:** an exorcism that infers correctly the impossibility of violating the Second Law without assuming the Second Law or anything that has not been derived or that is not an accepted axiom.

We will argue that there is no successful exorcism yet



## What papers this talk is mainly based on

- **Exorcist XIV: The Wrath of Maxwell's Demon. Part I.**  
From Maxwell to Szilard.  
Earman and Norton  
Stud. Hist. Phil. Mod. Phys., Vol 29, No. 4 p435--471,  
1998
- **Exorcist XIV: The Wrath of Maxwell's Demon. Part II.**  
From Szilard to Landauer and Beyond.  
Earman and Norton  
Stud. Hist. Phil. Mod. Phys., Vol 30, No. 1 p1--40,  
1999



# Maxwell's Demon: critique of existing research literature

- Introduction
  - Why the Second Law began to be challenged
- Problems of the exorcisms
  - Considerations of particular demons only
  - Earman and Norton's dilemma
- Comments on Bennett's exorcism
- Summary



# Introduction

Why the Second Law began to be challenged

# Why the Second Law began to be challenged

- Thermodynamics
  - A macroscopic theory: systems can be described by few state variables
- Kinetic Theory
  - Many aspects of thermodynamics can be derived microscopically
  - The idea that matter like gases consists of particles led Maxwell to consider the “Demon”

# Why the Second Law began to be challenged

## Maxwell's Demon

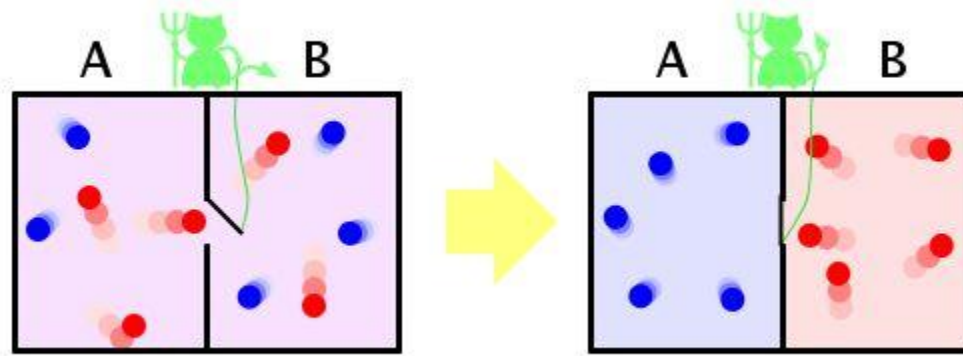

- Particles' velocities are Maxwell-Boltzmann-distributed → different velocities
- The demon opens the door for fast particles going from A to B and for slow particles going from B to A (which can in principle be done with no work)
- A temperature difference has been built up which can be used to produce work
- Total effect: work has been produced only by cooling down the gas → violation of the Second Law?
- Maxwell did **not** want to say that he had found a way to violate the Second Law!



# Why the Second Law began to be challenged

## Maxwell's letter to Tait

Leff, H.S. & Rex, A.F. (eds) (2003). Maxwell's Demon 2: Entropy, Classical and Quantum Information, Computing. Institute of Physics. ISBN 0-7503-0759-5

Page 5:

Maxwell clarified his view of the demon (quoted in Knott, 1911) in an undated letter to Tait:

*Concerning Demons.*

1. *Who gave them this name? Thomson.*
2. *What were they by nature? Very small BUT lively beings incapable of doing work but able to open and shut valves which move without friction or inertia.*
3. ***What was their chief end? To show that the 2<sup>nd</sup> Law of Thermodynamics has only a statistical certainty.***
4. *Is the production of an inequality of temperature their only occupation? No, for less intelligent demons can produce a difference in pressure as well as temperature by merely allowing all particles going in one direction while stopping all those going the other way. This reduces the demon to a valve. As such value him. Call him no more a demon but a valve like that of the hydraulic ram, suppose.*

# Why the Second Law began to be challenged

## Maxwell's emphasis

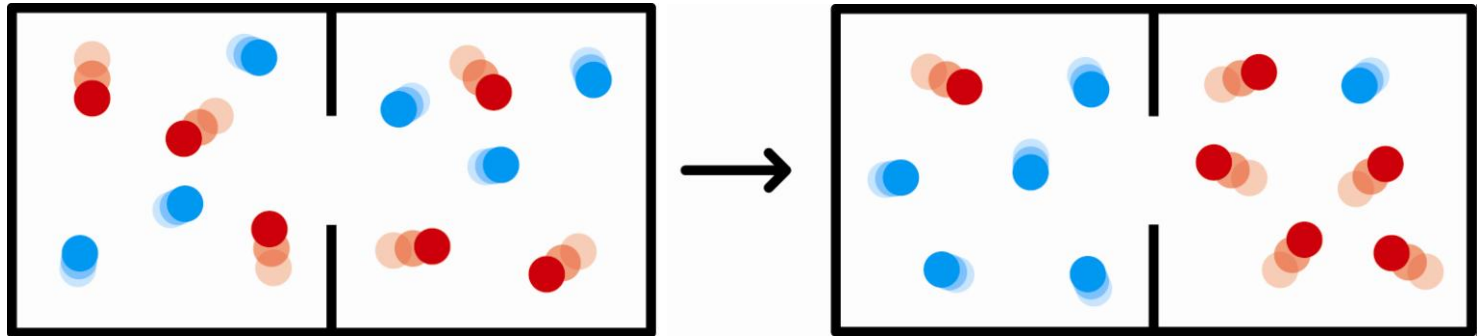

- Let us consider a twelve-particle-gas
- Let the door open all the time (no demon!)
- It's probable that temporary temperature differences between the two chambers will occur
- Maxwell's emphasis:
  - **The Second Law has a statistical character**

# Why the Second Law began to be challenged

- Thermodynamics
  - A macroscopic theory: systems can be described by few state variables
- Kinetic Theory
  - Many aspects of thermodynamics can be derived microscopically
  - The idea that matter like gases consists of particles led Maxwell to consider the “Demon”.
- Maxwell’s Demon
  - Maxwell’s emphasis: the Second Law has a statistical character

# Why the Second Law began to be challenged

## Fluctuation phenomena

- The recognition came that fluctuation phenomena can be observed in the laboratory (e.g. Brownian motion)
- They were seen as microscopically visible violations of the Second Law
- The fear grew that these microscopic “violations” of the Second Law could be accumulated or amplified to macroscopic ones
- People moved away from Maxwell’s intention (discussion of the range of validity and the statistical character of the Second Law) and started to think about how the Demon could be exorcised



# Why the Second Law began to be challenged

- Thermodynamics
  - A macroscopic theory: systems can be described by few state variables
- Kinetic Theory
  - Many aspects of thermodynamics can be derived microscopically
  - The idea that matter like gases consists of particles led Maxwell to consider the “Demon”.
- Maxwell’s Demon
  - Maxwell’s emphasis: the Second Law has a statistical character
  - People moved away from Maxwell’s intention and started to think about how the Demon can be exorcised



# Problems of the exorcisms (stated by Earman and Norton)

Taking Szilard's one-molecule-engine as an example

# Problems of the exorcisms

## Szilard's one-molecule-engine

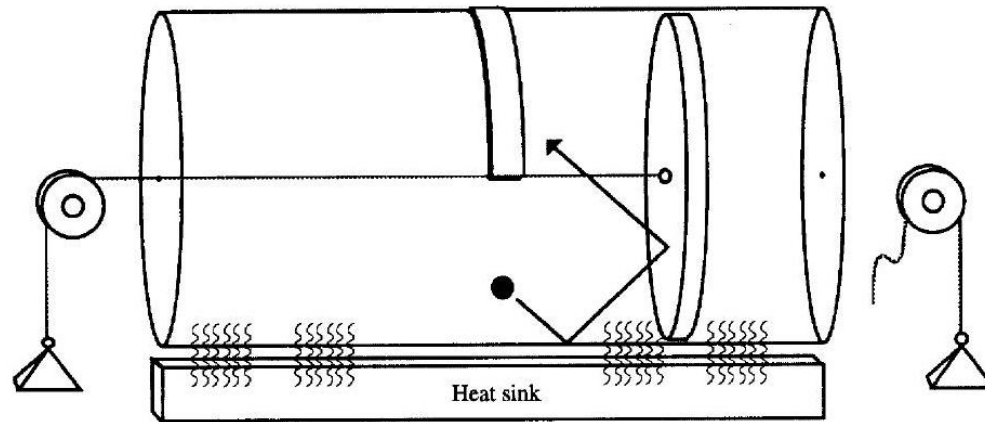

- Forget about entropy generation due to information acquisition for instance.
- Let us assume that we want the Second Law to hold for the one-molecule-engine.
- As Szilard stated, running through a cycle reduces the system's entropy (if we do *not* assume any entropy generation due to information acquisition). That means that we have to find out how the entropy reduction is compensated.



## Problems of the exorcisms

### Szilard's one-molecule-engine

- Why should we consider the entropy compensation to be caused by information acquisition?
- Szilard shows that an entropy generation due to information acquisition would save the Second Law **in this particular case**. But what does that tell us about the general impossibility of violating the Second Law?



## Problems of the exorcisms

- **Considerations of particular demons only**
  - It is not clear how to infer the general impossibility of violating the Second Law from the considered particular demons

# Problems of the exorcisms

Szilard, "On the decrease of entropy in a thermodynamic system by the intervention of intelligent beings" original from (1929), translation in Maxwell's demon: Entropy, Information, Computing, Leff and Rex, Princeton Univ. press pp. 124-133 (1990)

## ON THE DECREASE OF ENTROPY IN A THERMODYNAMIC SYSTEM BY THE INTERVENTION OF INTELLIGENT BEINGS

by *Leo Szilard*

*Translated by Anatol Rapoport and Mechthilde Knoller from the original article "Über die Entropieverminderung in einem thermodynamischen System bei Eingriffen intelligenter Wesen." Zeitschrift für Physik, 1929, 53, 840-856.*

The objective of the investigation is to find the conditions which apparently allow the construction of a perpetual-motion machine of the second kind, if one permits an intelligent being to intervene in a thermodynamic system. When such beings make measurements, they make the system behave in a manner distinctly different from the way a mechanical system behaves when left to itself. We show that it is a sort of a memory faculty, manifested by a system where measurements occur, that might cause a permanent decrease of entropy and thus a

resulting quantity of entropy. We find that it is exactly as great as is necessary for full compensation. The actual production of entropy in connection with the measurement, therefore, need not be greater than Equation (1) requires.

THERE is an objection, already historical, against the universal validity of the Second Law of Thermodynamics, which indeed looks rather ominous. The objection is embodied in the notion of Maxwell's demon, who in a different form appears even now-

At  
first we calculate this production of entropy quite generally from the postulate that full compensation is made in the sense of the Second Law (Equation [1]).

entropy production—we shall calculate the tuating parameter. However, one cannot

# Problems of the exorcisms

## Szilard's one-molecule-engine

It is not clear what Szilard assumes and what he infers. His paper can be interpreted in two ways:

- He assumes the Second Law. From this assumption, he infers a compensating entropy cost.  
→ **He saves the Second Law by assuming it.** From this point of view, his statement is not false, but meaningless. In terms of the Second Law discussion, it's reducible to the trivial statement „the Second Law holds → the Second Law holds“.
- For heuristic reasons (not by assumption), he considers the Second Law's statement (non-decreasing entropy) to set up an equation to calculate an entropy cost. Then he forgets about the Second Law and **postulates an entropy cost** due to information acquisition. **From this postulate, he infers the Second Law.** Also this is not false, but to eventually verify the Second Law, we would have to verify the new postulate.

Both ways do not lead to a successful exorcism!

## Problems of the exorcisms

- Considerations of particular demons only
    - It is not clear how to infer the general impossibility of violating the Second Law from the considered particular demons
  - Unclear what is assumed and what is inferred
    - It's quite unclear whether the stated principle is a consequence of the supposition of the Second Law or an independent postulate.
- Earman and Norton's Dilemma



# Earman and Norton's Dilemma

Dilemma for an information theoretic exorcism of the Demon

## Earman and Norton's Dilemma

Exorcist XIV: The Wrath of Maxwell's Demon. Part II. From Szilard to Landauer and Beyond.

Earman and Norton

Stud. Hist. Phil. Mod. Phys., Vol 30, No. 1 p1--40, 1999

Page 2

*Dilemma for an information theoretic exorcism of the Demon:* Either the combination of object system and Demon forms a canonical thermal system or it does not. In the first case ('sound'), it follows that the Second Law of thermodynamics obtains (in suitable form) for the combined system so that there can be no total reduction in entropy no matter how the Demon may interfere with the object system, beyond that allowed by the applicable form of the Second Law. This result is automatic and no information theoretic notions are needed to generate it. In the second case ('profound'), we need a new physical postulate to ensure that the Second Law holds for the combined system. Any such postulate, either a general one or one specifically relating entropy and information, requires independent justification. We do not believe that the literature has succeeded in providing such justification. Moreover, there is reason to doubt that any such justification is possible for a postulate couched in terms of the entropy cost of information acquisition and/or processing. For having departed from canonical thermal systems, one must confront systems where anti-entropic behaviour can occur and where there is no natural way to identify a component of the system occupying the role of information gatherer/processor.

# Earman and Norton's Dilemma

## *Dilemma for an information theoretic exorcism of the Demon*

### **EITHER**

- The combination of object system and Demon forms a canonical thermal system(\*).  
It follows that the Second Law of thermodynamics holds for the combined system. This result is automatic and no information theoretic notions are needed to generate it.

**sound case** of the dilemma

### **OR**

- The combination of object system and Demon does *not* form a canonical thermal system(\*).  
Then we need a new physical postulate to ensure that the Second Law holds for the combined system. Any such postulate, either a general one or one specifically relating entropy and information, requires independent justification.

**profound case** of the dilemma

(\*): Earman and Norton define a canonical thermal system as follows:  
„We may define a canonical thermal system as one that obeys the standard laws of thermodynamics; [...]“

# Earman and Norton's Dilemma

## Example: Szilard's one-molecule-engine

Remember what we have said about Szilard's paper. There are two possible interpretations:

- He assumes the Second Law  $\rightarrow$  infers an entropy cost

**This is the sound case of the dilemma!**

- He postulates an entropy cost  $\rightarrow$  infers the Second Law

**This is the profound case of the dilemma!**





# Comments on Bennett's exorcism

Why Bennett has not successfully exorcised the  
Demon

# Notes on Bennett's exorcism

Exorcist XIV: The Wrath of Maxwell's Demon. Part II. From Szilard to Landauer and Beyond. Earman and Norton. Stud. Hist. Phil. Mod. Phys., Vol 30, No. 1 p1--40, 1999

14

*Studies in History and Philosophy of Modern Physics*

balanced keel, attached to the pistons. That tipping purportedly reveals the position of the molecule without entropy cost. (Bennett (1982, p. 240) describes an electronic analog of this device in which the location of a diamagnetic particle is revealed when it flips the state of a bistable ferromagnet.) The difficulty with Bennett's proposal is that the mechanical keel system described is an ordinary mechanical device that would be governed by a Hamiltonian mechanics. As a result we must presume that it would behave like a canonical thermal system. That would mean that it would be subject to the usual fluctuation phenomena. Intuitively, these fluctuations would arise as a wild rocking of the keel resulting from its recoils upon each of the many impacts with the molecule of the gas. If the keel is light enough to be raised by the pressure of the one-molecule gas, then it must have very little inertia and such rocking is to be expected. Presumably this wild rocking would obliterate the keel's measuring function. Similar fluctuation problems would trouble electronic analogues of this device. Whether these fluctuations problems would defeat Chabada's proposal and Jauch and Baron's is unclear because their descriptions do not give sufficient detail of the complete apparatus proposed.

On page 14, we find:



To use the information it acquires, for example, about the location of a molecule in Szilard's one-molecule engine, the Demon must record that information in some physical memory storage device. If a thermodynamic cycle is to be completed, this memory must be erased. It is in this step, Bennett claims, that there is an inevitable entropy cost. Insofar as there is an official doctrine about the exorcism of Maxwell's Demon, this is it, as evidenced by the endorsements it has received in leading scientific journals and conference proceedings (see, for example, Caves (1993, 1994), Schumacher (1994), Zurek (1989a, 1989b, 1990)) and even by Feynman (1996, pp. 149–150).

(1994), Zurek (1989a, 1989b, 1990)) and even by Feynman (1996, pp. 149–150). Bennett (1987, p. 116) summarised the argument for Landauer's Principle:

Landauer's proof begins with the premise that distinct logical states of a computer must be represented by distinct physical states of the computer's hardware. For example, every possible state of the computer's memory must be represented by a distinct physical configuration (that is, a distinct set of currents, voltages, fields and so forth).

Suppose a memory register of  $n$  bits is cleared; in other words, suppose the value in each location is set at zero, regardless of the previous value. Before the operation

# Notes on Bennett's exorcism

## Bennett's argument

Bennett argues as follows:

- In order to violate the Second Law, the Demon has to gather information
- To work cyclically, the Demon has to erase the information on the end of every cycle
- Erasure is logically irreversible. As Landauer stated, logically irreversible procedures cause an entropy increase
- The amount of the entropy increase compensates the entropy decrease due to the usage of the information

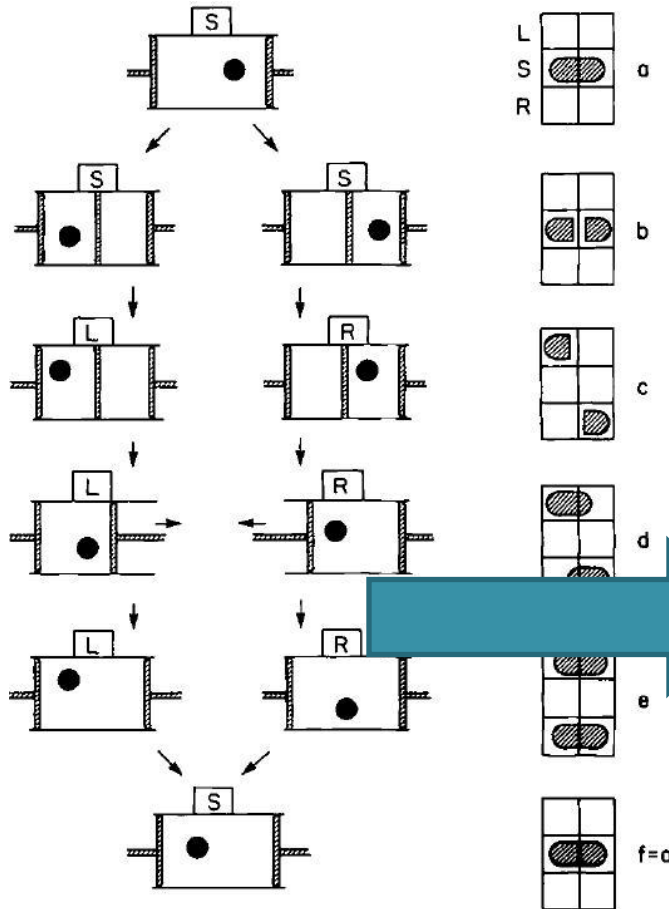

# Notes on Bennett's exorcism

Landauer, R. Irreversibility and Heat Generation in the Computing Process. IBM Journal of Research and Development, 3, 183-191

## Irreversibility and Heat Generation in the Computing Process



Let us turn to page 5 of the paper, chapter 4: logical irreversibility and entropy generation

**Abstract:** It is argued that devices that do not have a single-valued inverse. This logical irreversibility is associated with physical irreversibility and requires a minimal heat generation, per machine cycle, typically of the order of  $kT$  for each irreversible function. This dissipation serves the purpose of standardizing signals and making them independent of their exact logical history. Two simple, but representative, models of bistable devices are subjected to a more detailed analysis of switching kinetics to yield the relationship between speed and energy dissipation, and to estimate the effects of errors induced by thermal fluctuations.

### 1. Introduction

The search for faster and more compact computing circuits leads directly to the question: What are the ultimate physical limitations on the progress in this direction? In practice the limitations are likely to be set by the need for access to each logical element. At this time, however, it is still hard to understand what physical requirements this puts on the degrees of freedom which bear information. The existence of a storage medium as compact as the genetic one indicates that one can go very far in the direction of compactness. at least if we are prepared to

degree of freedom associated with the information. Classically a degree of freedom is associated with  $kT$  of thermal energy. Any switching signals passing between devices must therefore have this much energy to override the noise. This argument does not make it clear that the signal energy must actually be dissipated. An alternative way of anticipating our conclusions is to refer to the arguments by Brillouin and earlier authors, as summarized by Brillouin in his book, *Science and Information Theory*,<sup>1</sup> to the effect that the measurement process requires a

# Notes on Bennett's exorcism

Landauer, R. Irreversibility and Heat Generation in the Computing Process. IBM Journal of Research and Development, 3, 183-191

nonterminating program. Let us take such a machine as it normally comes, involving logically irreversible truth functions. An irreversible truth function can be made into a reversible one, as we have illustrated, by "embedding" it in a truth function of a large number of variables. The larger truth function, however, requires extra inputs to bias it, and extra outputs to hold the information which provides the reversibility. What we now contend is that this larger machine, while it is reversible, is not a useful computing machine in the normally accepted sense of the word.

First of all, in order to provide space for the extra inputs and outputs, the embedding requires knowledge of

one of  $2^N$  states (for  $N$  bits in the assembly) and therefore the entropy can increase by  $kN \log_2 2$  as the initial information becomes thermalized.

Note that our argument here does not necessarily depend upon connections, frequently made in other writings, between entropy and information. We simply think of each bit as being located in a physical system, with perhaps a great many degrees of freedom, in addition to the relevant one. However, for each possible physical state which will be interpreted as a ZERO, there is a very similar possible physical state in which the physical system represents a ONE. Hence a system which is in a ONE state has only half as many physical states available to it

The entropy therefore has been reduced by  $k \log_e 2 = 0.6931 k$  per bit. The entropy of a closed system, e.g., a computer with its own batteries, cannot decrease; hence this entropy must appear elsewhere as a heating effect, supplying  $0.6931 kT$  per restored bit to the surroundings.



thermal equilibrium the bits (or spins) have two equally favored positions. Our specially prepared collections show much more order, and therefore a lower temperature and entropy than is characteristic of the equilibrium state. In the adiabatic demagnetization method we use such a prepared spin state, and as the spins become disoriented they take up entropy from the surroundings and thereby cool off the lattice in which the spins are embedded. An assembly of ordered bits would act similarly. As the assembly thermalizes and forgets its initial state the environment would be cooled off. Note that the important point here is not that all bits in the assembly initially agree with each other, but only that there is a single, well-defined initial state for the collection of bits. The well-defined initial state corresponds, by the usual statistical mechanical definition of entropy,  $S = k \log W$ , to zero entropy. The degrees of freedom associated with the information can, through thermal relaxation, go to any

applied to a random chain of ONES and ZEROS. We can, in the usual fashion, take the statistical ensemble equivalent to a time average and therefore conclude that the dissipation per reset operation is the same for the time-wise succession as for the thermalized ensemble.

A computer, however, is seldom likely to operate on random data. One of the two bit possibilities may occur more often than the other, or even if the frequencies are equal, there may be a correlation between successive bits. In other words the digits which are reset may not carry the maximum possible information. Consider the extreme case, where the inputs are all ONE, and there is no need to carry out any operation. Clearly then no entropy changes occur and no heat dissipation is involved. Alternatively if the initial states are all ZERO they also carry no information, and no entropy change is involved in resetting them all to ONE. Note, however, that the reset operation which sufficed when the inputs were all ONE (doing



# Notes on Bennett's exorcism

## Bennett's argument

- Landauer's erasure principle has been inferred from the **assumption of the Second Law!**
- Bennett argued that Landauer's erasure principle provides the entropy compensation
- Thus, Bennett has exorcised the Demon with the assumption of the Second Law, i.e. **he has saved the Second Law by assuming it!**
- Bennett's paper is subject to the sound case of the dilemma
- This is what also Earman and Norton have stated:

# Notes on Bennett's exorcism

Exorcist XIV: The Wrath of Maxwell's Demon. Part II. From Szilard to Landauer and Beyond. Earman and Norton. Stud. Hist. Phil. Mod. Phys., Vol 30, No. 1 p1--40, 1999

*Exorcist XIV: The Wrath of Maxwell's Demon. Part II*

15

the register as a whole could have been in any of  $2^n$  states. After the operation the register can be in only one state. The operation therefore compressed many logical states into one, much as a piston might compress a gas.

By Landauer's premise, in order to compress a computer's logical state one must also compress its physical state: one must lower the entropy of its hardware. According to the second law, this decrease in the entropy of the computer's hardware cannot be accomplished without a compensating increase in the entropy of the computer's environment. Hence one cannot clear a memory register without generating heat and adding to the entropy of the environment. Clearing a memory is a thermodynamically irreversible operation [our emphasis].

On page 15, we find:

Bennett's synopsis agrees with Landauer's own development such as in Landauer (1961, §4). It makes clear that Landauer's Principle depends on some very definite assumptions about the physical process of memory erasure. That is, the memory registers are thermalised for at least part of the erasure process. Without this thermalisation, the Second Law of thermodynamics could not be invoked and the entropy cost of erasure assessed. For example, we may represent  $n$  bits of information with the positions of  $n$  particles in  $n$  chambers; a zero might be represented by the particle on the left side of its chamber and a one represented by the particle in the right side. To erase some memory state, we allow the particles to gain thermal energy if they do not already have it, and then release them so they can move to both sides of their chambers with that thermal energy. The erasure is completed by compressing the thermalised particles to the zero state of all particles in the left of their chambers. An isothermal, reversible compression would release heat from the memory device and correspondingly reduce its entropy. There would be a compensating increase of entropy in the environment that absorbs the heat released during compression.<sup>8</sup>

In terms of our dilemma, this treatment again chooses the 'sound' horn. Its central principle, Landauer's Principle, depends on the assumption that the demonic apparatus is constituted of canonical thermal systems, at least in its crucial elements. Thus the explanation of the failure of the Demon to effect a net entropy reduction lies simply in the assumption that the Second Law governs the Demon as well as the system he acts upon.

constant. However, in the first step of the erasure, the thermalised particles are released from confinement to one or other side of their chambers. This release corresponds to an irreversible expansion. The system's entropy increases without any compensating decrease in the entropy of the environment, so that the total entropy of the universe increases.



## Notes on Bennett's exorcism

Bennett has taken notice of this objection. In a recent paper (February 2008), he wrote:



# Notes on Bennett's exorcism

Charles H. Bennett, "Notes on Landauer's principle, Reversible Computation, and Maxwell's Demon", IBM Research Division, Yorktown Heights, NY 10598, USA (February 2, 2008)

Notes on Landauer's Principle, Reversible Computation, and Maxwell's Demon

Charles H. Bennett

IBM Research Division, Yorktown Heights, NY 10598, USA — [bennetc@watson.ibm.com](mailto:bennetc@watson.ibm.com)  
(February 2, 2008)

Landauer's principle, often regarded as the basic principle of the thermodynamics of information processing, holds that any logically irreversible manipulation of information, such as the erasure of a bit or the merging of two computation paths, must be accompanied by a corresponding entropy increase in non-information-bearing degrees of freedom of the information processing apparatus or its environment. Conversely, it is generally accepted that any logically reversible transformation of information can in principle be accomplished by an appropriate physical mechanism operating in a thermodynamically reversible fashion. These notions have sometimes been criticized either as being false, or as being trivial and obvious, and therefore unhelpful for purposes such as explaining why Maxwell's Demon cannot violate the Second Law of thermodynamics. Here I attempt to refute some of the arguments against Landauer's principle, while arguing that although in a sense it is indeed a straightforward consequence or restatement of the Second Law, it still has considerable pedagogic and explanatory power, especially in the context of other influential ideas in 19<sup>th</sup> and 20<sup>th</sup> century physics. Similar arguments have been given by Jeffrey Bub [1]

Page 1:

Landauer's Principle



So let us turn to the third section of the paper

## Objections to Landauer's Principle

One of the main objections to Landauer's principle, and in my opinion the one of greatest merit, is that raised by Earman and Norton [3], who argue that since it is not independent of the Second Law, it is either unnecessary or insufficient as an exorcism of Maxwell's demon. I will discuss this objection further in the third section.

# Notes on Bennett's exorcism

Charles H. Bennett, "Notes on Landauer's principle, Reversible Computation, and Maxwell's Demon", IBM Research Division, Yorktown Heights, NY 10598, USA (February 2, 2008)

Page 5:

of Szilard's engine, including those discussed by Earman and Norton, and that depicted in Fig. 1 of the present paper, are of this type, as are most of the proposed realizations of quantum computers. The thermodynamic cost of operating such a machine is the work done by the external agency, integrated over the cycle or sequence of operations. Mergings of trajectories are possible, but are thermodynamically costly if applied to nonrandom data, by the arguments given above. If such mergings are avoided through reversible programming, these devices operate reversibly in the usual sense of thermodynamic thought experiments, ie their dissipation per step is proportional to the driving force, tending to zero in the limit of zero speed of operation.

- Fully Brownian machines, in which all coordinates are allowed to drift freely, within the constraints they mutually exert on one other. This kind of

ics of information processing ought therefore to include an understanding of the thermodynamics of error correction in a fault tolerant setting, a subject that appears to be in its infancy. A tractable toy example of fault tolerance, namely a Brownian copying system patterned on the proofreading enzymes involved in DNA replication, was studied in [18], and its dissipation/error tradeoff analyzed. A related problem arises with liquid state NMR quantum computation: although one can make the gates fairly reliable, only reversible gates are available and the initial thermal state is almost perfectly random. Schulman and Vazirani [19] have devised an algorithm for pumping the nonrandomness in a large number of thermal qubits into a few of them, leaving the rest perfectly random. Much work remains to be done on the dissipation/error tradeoff in more general settings.

Landauer's principle in the context of other ideas in 19<sup>th</sup> and 20<sup>th</sup> century physics

I would nevertheless argue that Landauer's principle serves an important pedagogic purpose of helping students avoid a misconception that many people have fallen into during the 20<sup>th</sup> century, including giants like von Neumann, Gabor, and Brillouin and even, perhaps, Szilard\*. This is the informal belief that there is an intrinsic cost of order  $kT$  for every elementary act of information processing, [...]

...entire energy barriers in minimalist models such as the clockwork computer of [5]. The theory of fault-tolerant computation, which has recently received a great deal of study in the context of quantum computing, aims to show how, through appropriate design and software, arbitrarily large reliable computations can be performed on imperfect hardware suffering some fixed rate of hardware errors. A full understanding of the thermodynam-

...and this model is not the paper and usually been incorrectly interpreted—the detailed mathematical analysis at the end (paragraphs preceding his eq. 21) shows the entropy increase as occurring during the resetting step, in accordance with Landauer's principle. Probably Szilard thought it less important to associate the entropy increase with a particular stage of the cycle than to show that it must occur somewhere during the cycle.

# Notes on Bennett's exorcism

## Bennett's paper

- Bennett has not successfully exorcised the Demon, since his argumentation is based on Landauer's erasure principle which assumes the Second Law.
- Nevertheless, Landauer's and Bennett's papers are very interesting. Accepting the Second Law, they provide an interesting interpretation of the necessary entropy compensation.

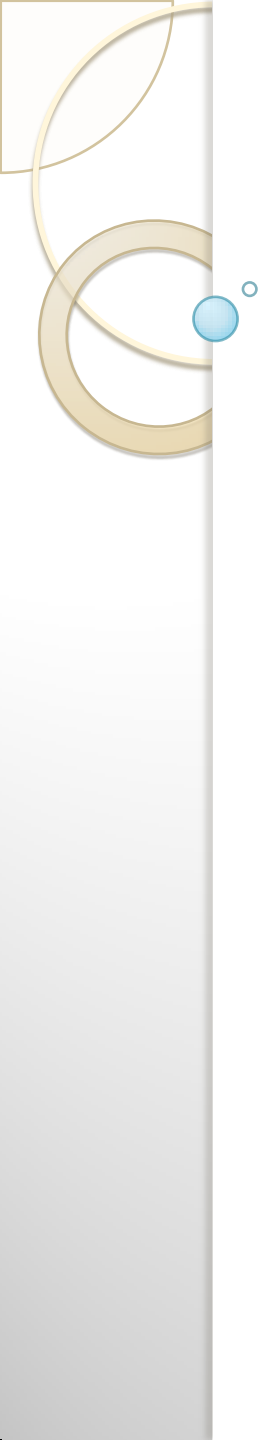

# Summary

# Summary

- Introduction

- Maxwell's emphasis: think about the statistical character of the Second Law
- People moved away from Maxwell's intention and started to think about how the Demon can be exorcised

# Summary

- Problems of the exorcisms
  - Considerations of particular demons only (It is not clear how to infer the general impossibility of violating the Second Law from the considered particular demons)
  - Unclear what is assumed and what is inferred
    - Earman and Norton's dilemma
      - Sound case: the Second Law is assumed
      - Profound case: a new physical postulate has to be verified



# Summary

- Comments on Bennett's exorcism
  - Bennett has not successfully exorcised the Demon because he has assumed the Second Law
  - Bennett's paper still has value in explaining consequences of the Second Law

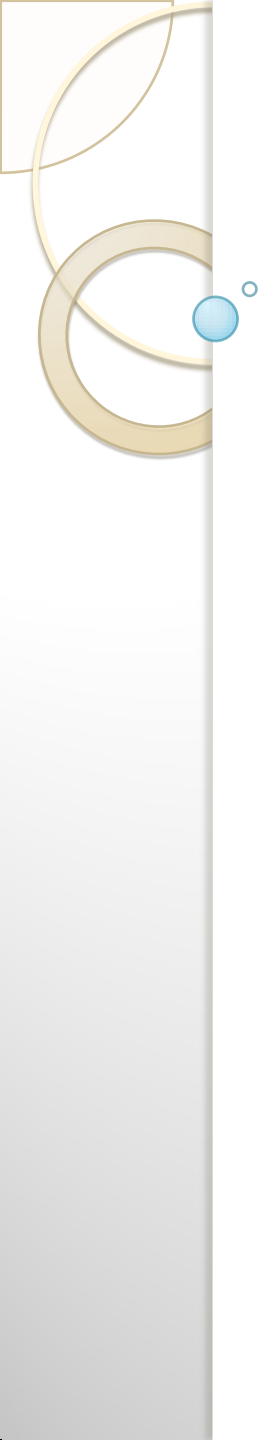

Questions?